



ACCESSORIES



WARNING

Accessories which are not properly fitted can be dangerous. Read the instructions carefully prior to fitting. Whilst fitting, comply with the instructions at all times. If in doubt, contact your nearest Land Rover Dealer.

ACHTUNG!

Nicht sachgemäß montiertes Zubehör kann gefährlich sein. Lesen Sie die Montageanleitung sorgfältig, bevor Sie das Teil montieren. Halten Sie sich bei der Montage an die Anleitung. Bei Unsicherheiten wenden Sie sich bitte an Ihren Land Rover Händler.

AVERTISSEMENT

Les accessoires qui ne sont pas correctement montés risquent d'être dangereux. Veuillez lire soigneusement les instructions avant d'effectuer la pose. Respectez toujours les instructions en cours de pose. En cas de doute, consultez votre concessionnaire Land Rover local.

AVISO

Aquellos accesorios que no hayan sido ajustados debidamente pueden resultar peligrosos. Lea las instrucciones detenidamente antes de iniciar el montaje. Durante el montaje siga las instrucciones en todo momento. En caso de duda póngase en contacto con su Concesionario de Land Rover.

AVVERTENZA

Gli accessori non sistemati come previsto possono essere pericolosi. Leggere attentamente le istruzioni prima del fissaggio. Durante il montaggio seguire sempre le relative istruzioni. In caso di dubbio rivolgersi al più vicino concessionario della Land Rover.

ADVERTÊNCIA!

Os Acessórios que não são montados adequadamente podem ser perigosos. Leia as instruções cuidadosamente antes de montar. Durante a montagem, obedeça as instruções todo o tempo. Se tiver alguma dúvida, contacte o Concessionário LandRover mais próximo.

WAARSHCUWING

Accessoires die niet op de juiste wijze zijn gemonteerd kunnen gevaar opleveren. Lees zorgvuldig de instructies alvorens met de montage te beginnen. Houd u tijdens de montage te allen tijde aan de instructies. Neem bij twijfel contact op met de dichtstbijzijnde Land Rover dealer.

ΠΡΟΕΙΔΟΠΟΙΗΣΗ

Τα προαιρετικά εξαρτήματα που δεν έχουν τοποθετηθεί σωστά μπορεί να είναι επικίνδυνα. Διαβάστε τις οδηγίες πριν προχωρήσετε στην τοποθέτησή τους. Κατά την τοποθέτηση, τηρείτε συνεχώς τις οδηγίες. Αν έχετε οποιαδήποτε αμφιβολία, επικοινωνήστε με τον πλησιέστερο αντιπρόσωπο της.

注意

正しく取り付けられていない備品があると、事故の原因になります。取付ける前にこのマニュアルをよくお読みください。取付けの際は必ずこのマニュアルにある指示に従ってください。何か不明な点がありましたら、お近くのランド・ローバー社のディーラーまでお問い合わせください。

FITTING INSTRUCTION

Auxiliary Wiring Kit

EINBAUANLEITUNG

Hilfskabelbaum

INSTRUCTION DE MONTAGE

Kit de câblage auxiliaire

ISTRUZIONI PER L'USO

Corredo cablaggio ausiliare

INSTRUCCION DE MONTAJE

Kit de cableado auxiliar

INSTRUÇÕES DE MONTAGEM

Kit de Fiação Auxiliar

MONTAGEHANDLEIDING

Aanvullende bedradingsset

ΟΔΗΓΙΑ ΤΟΠΟΘΕΤΗΣΗΣ

Κιτ Βοηθητικής Καλωδίωσης

取付け指示書

補助ワイヤ キット

LAND ROVER DISCOVERY

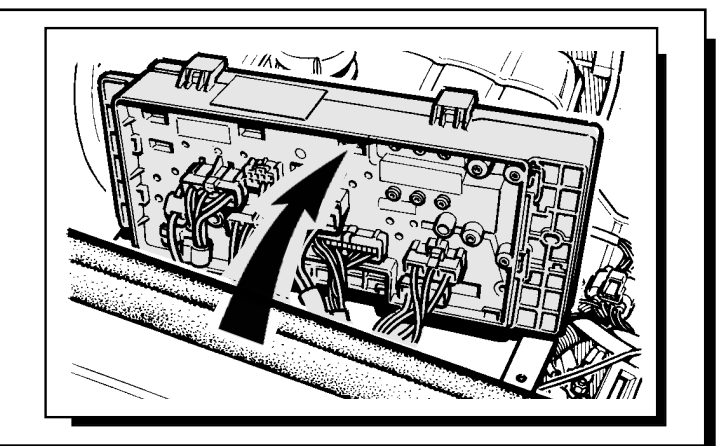
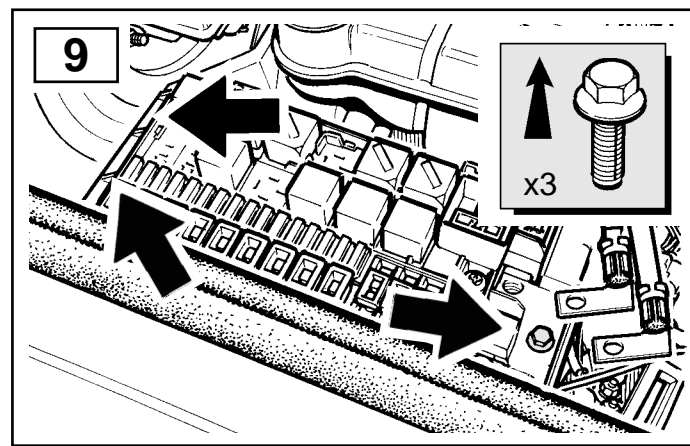
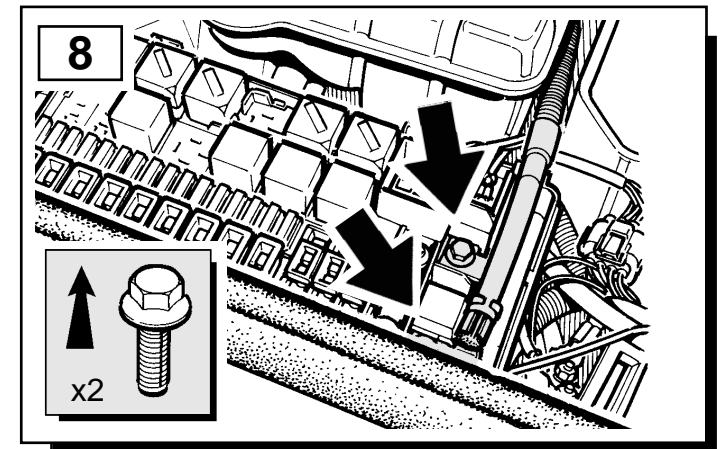
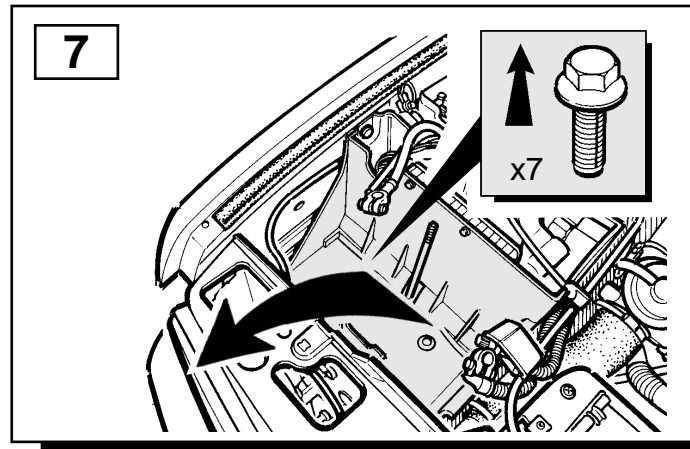
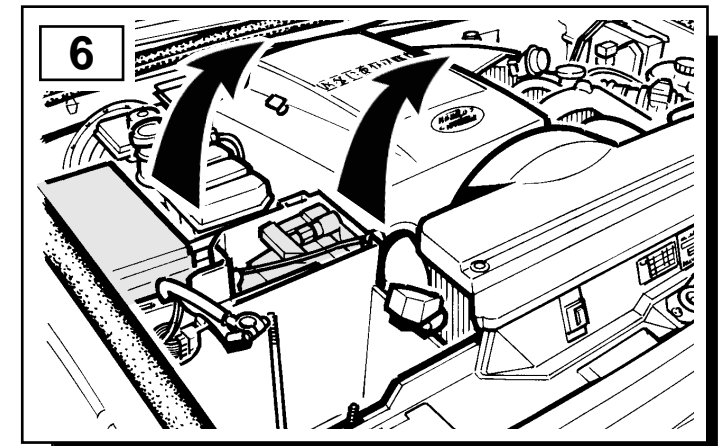
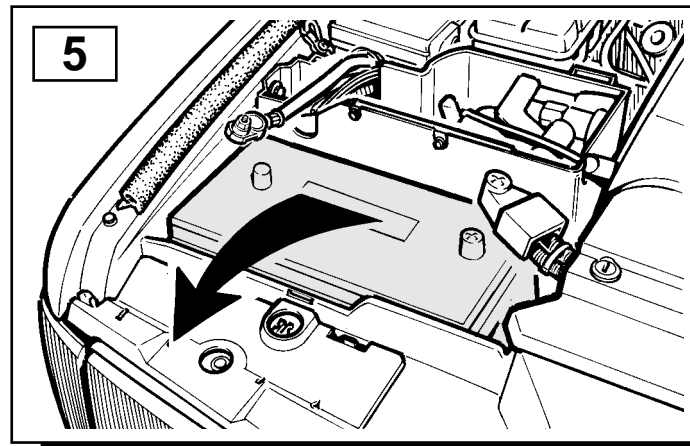
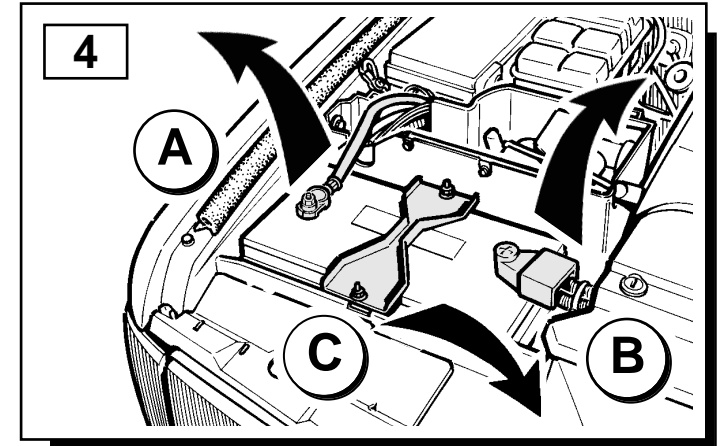
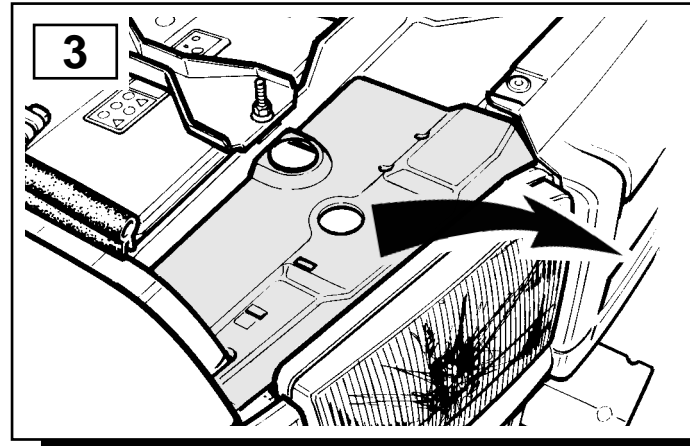
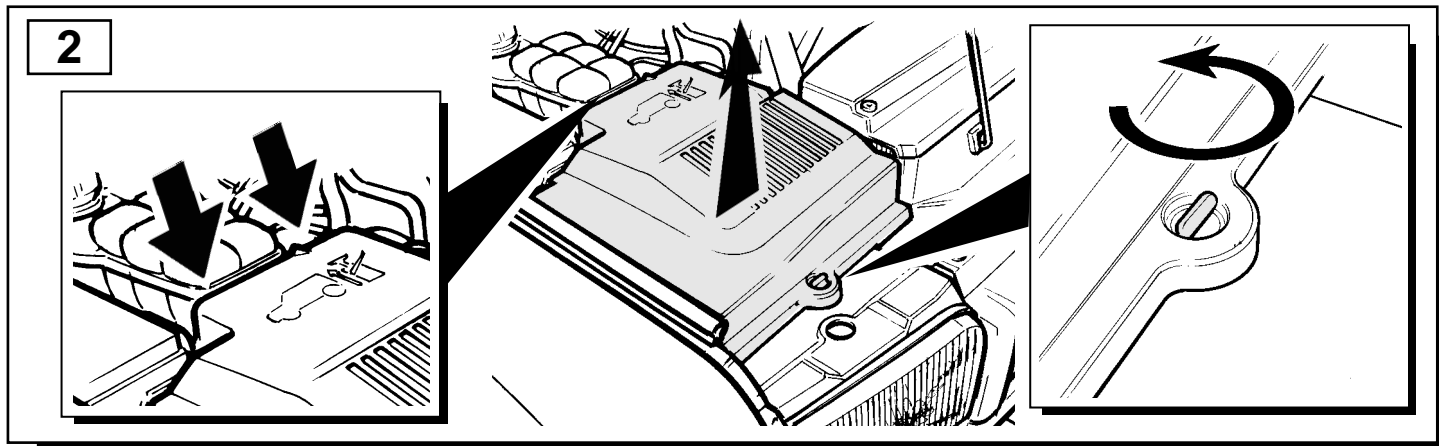
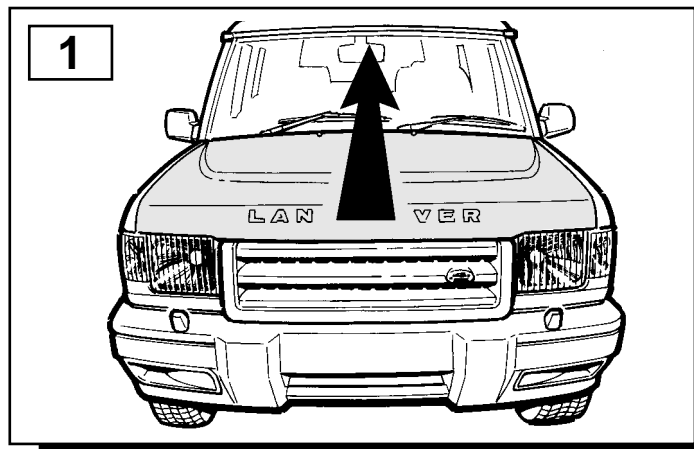
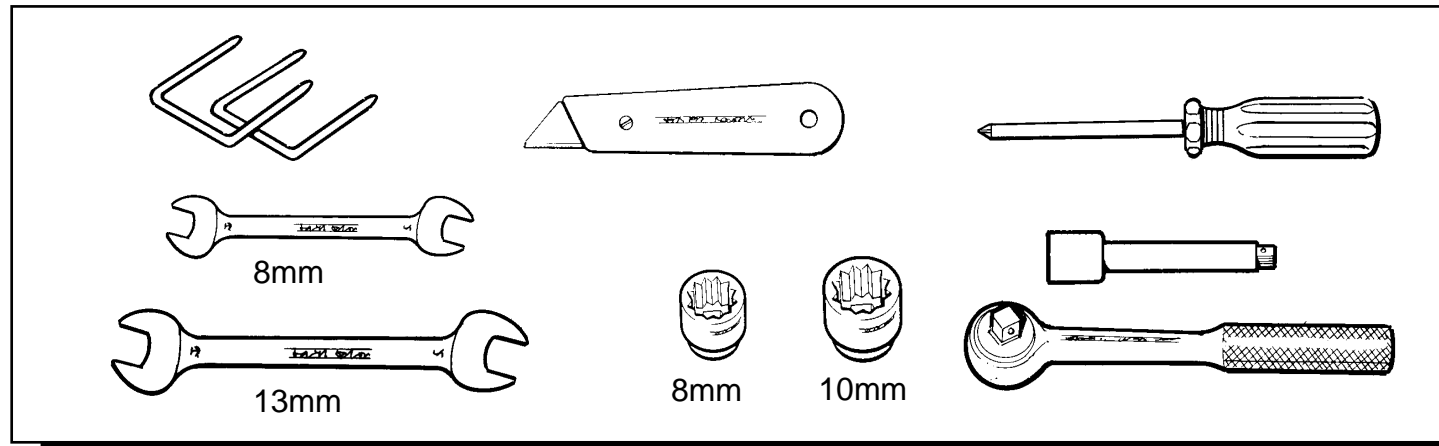
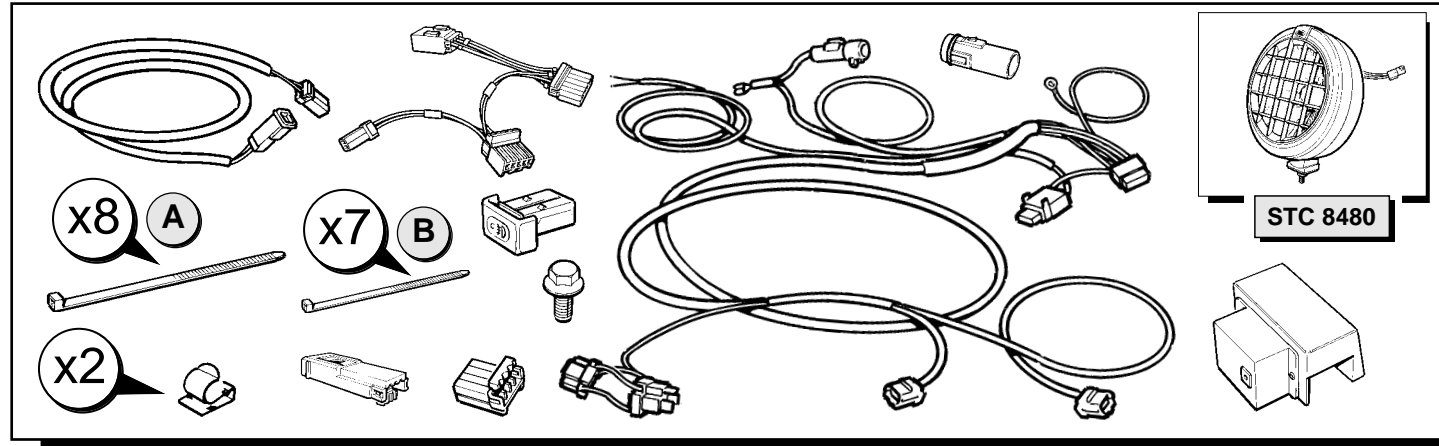

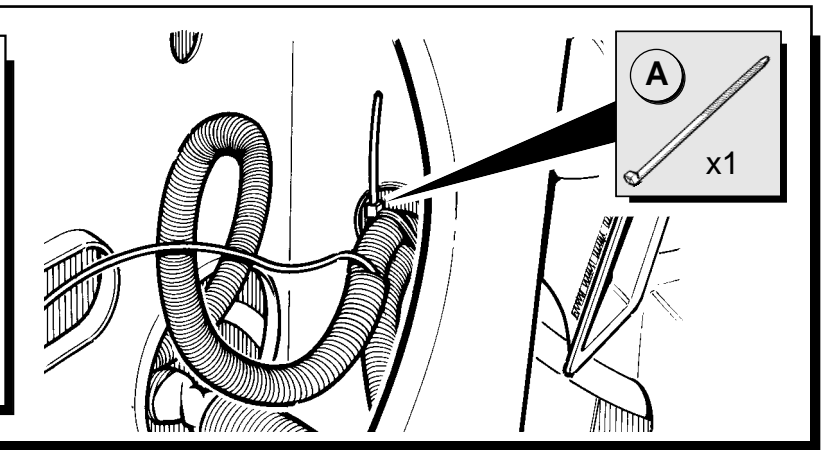
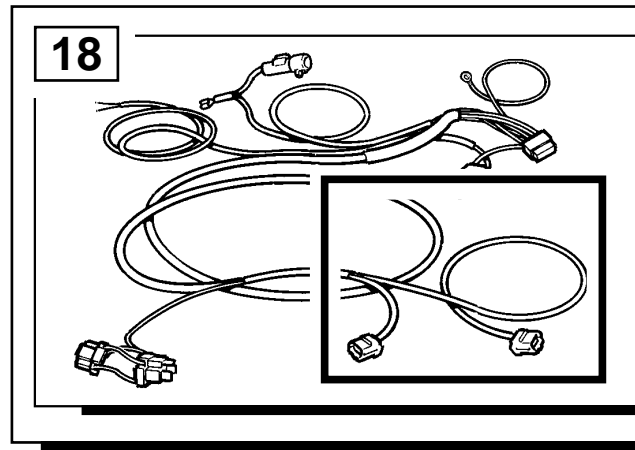
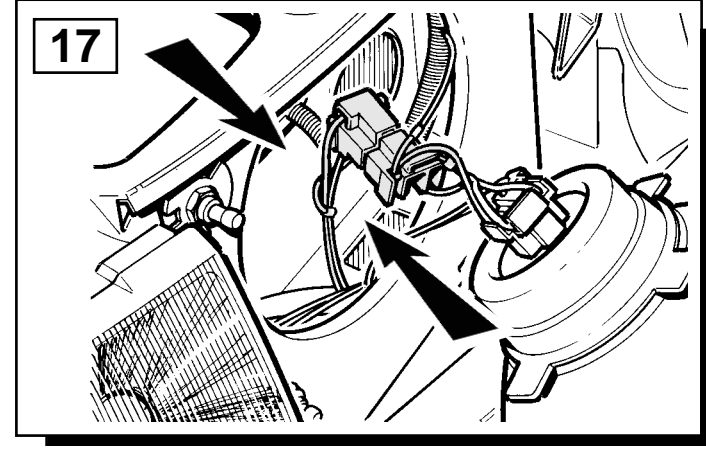
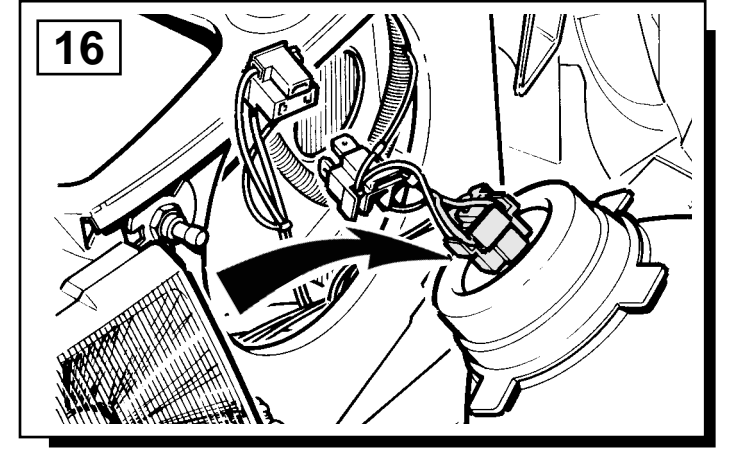
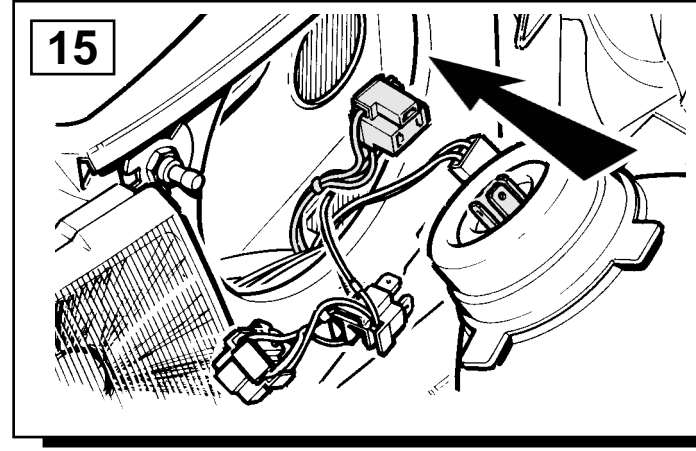
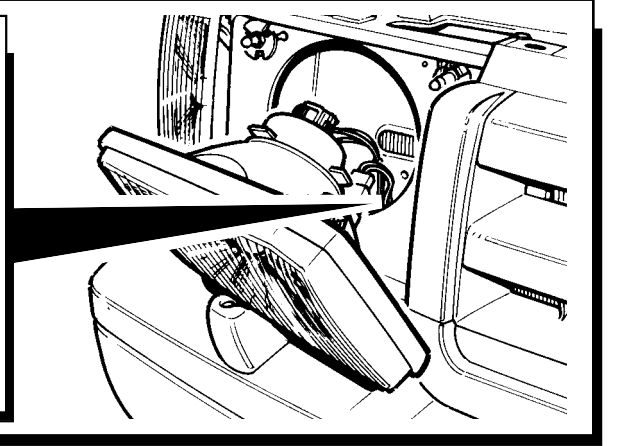
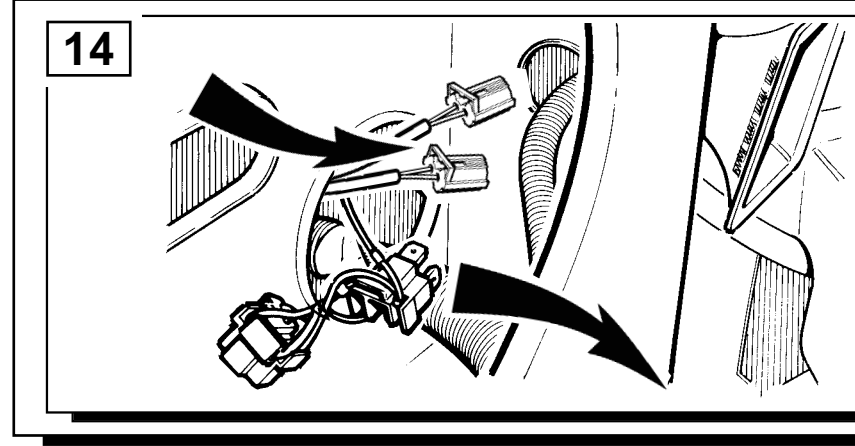
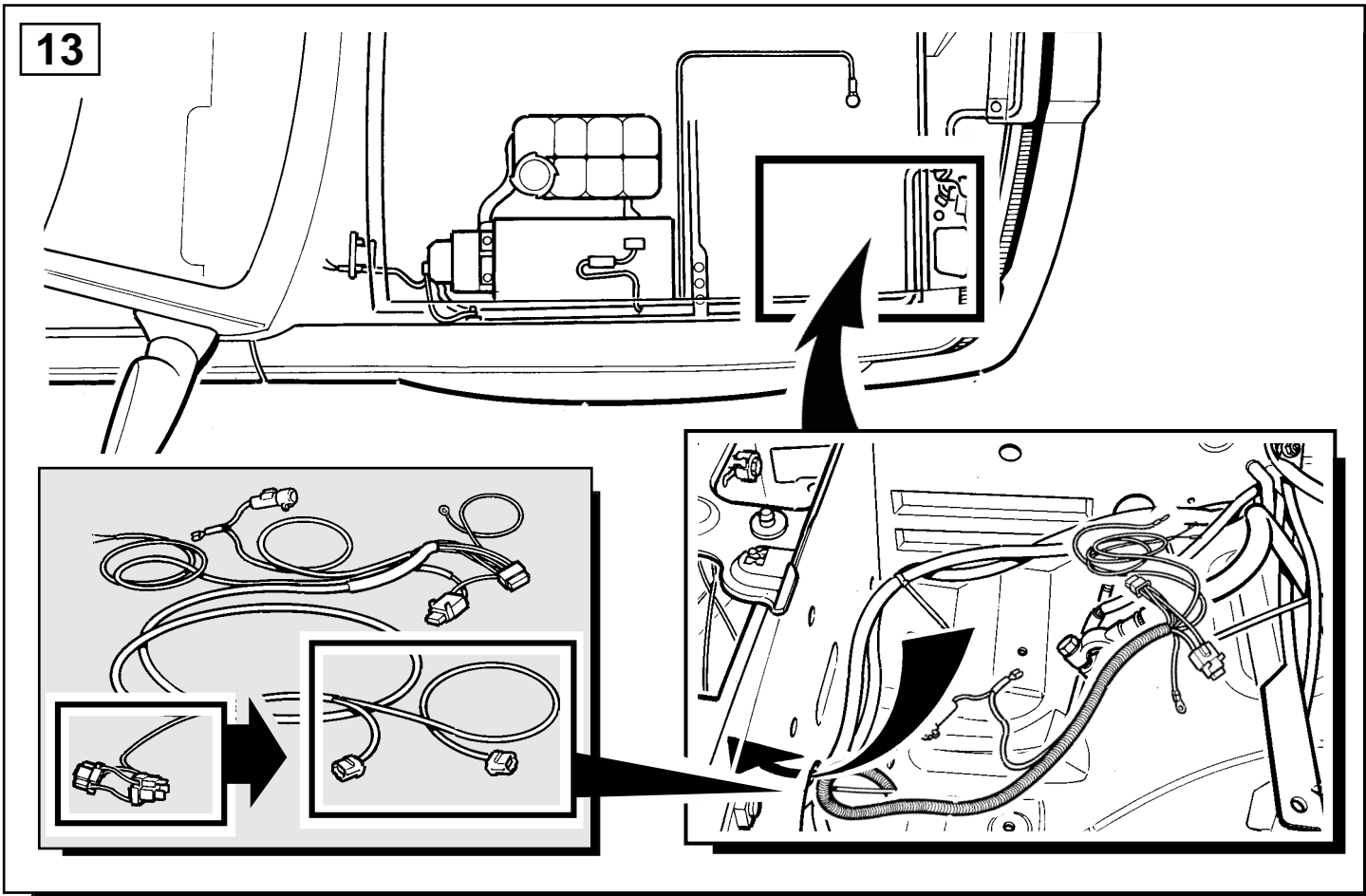
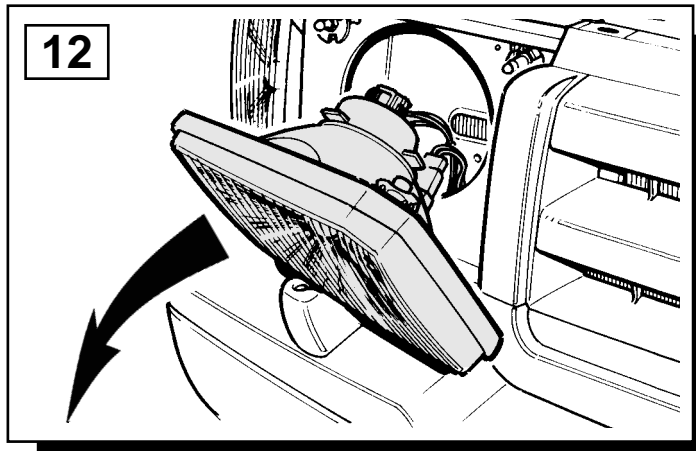
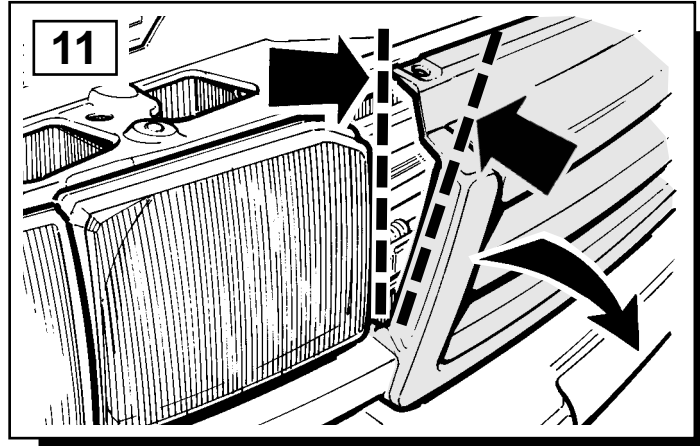
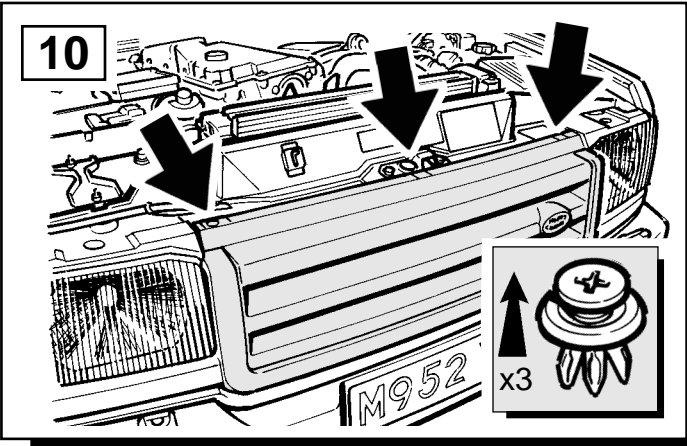

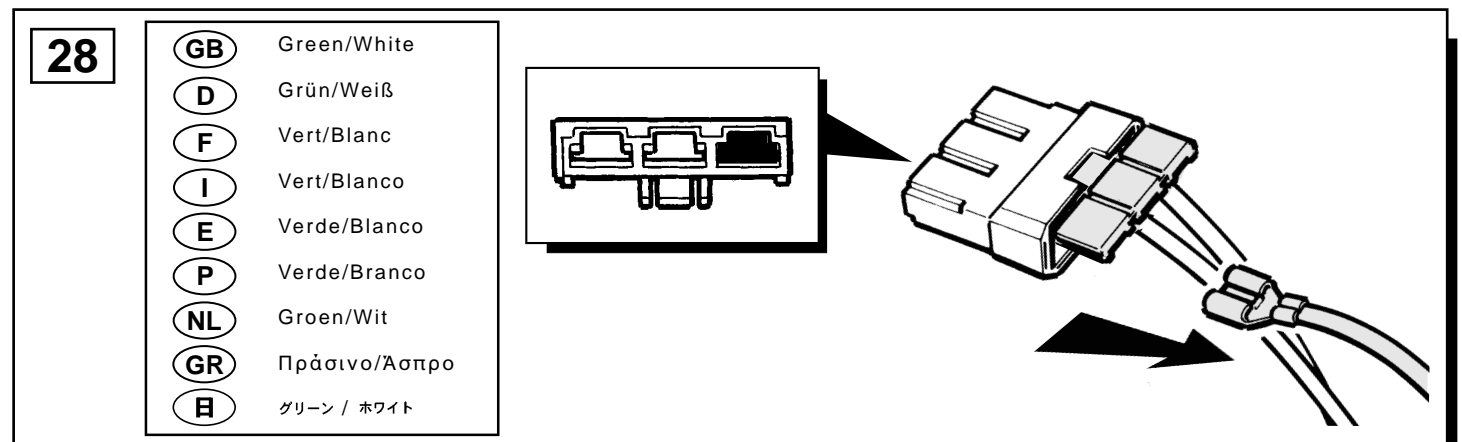
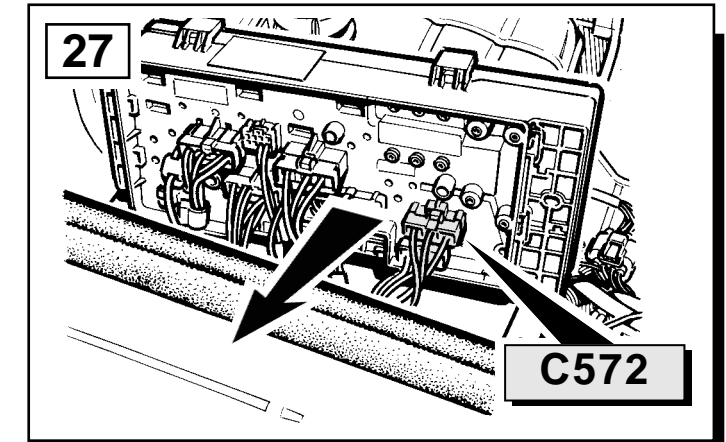
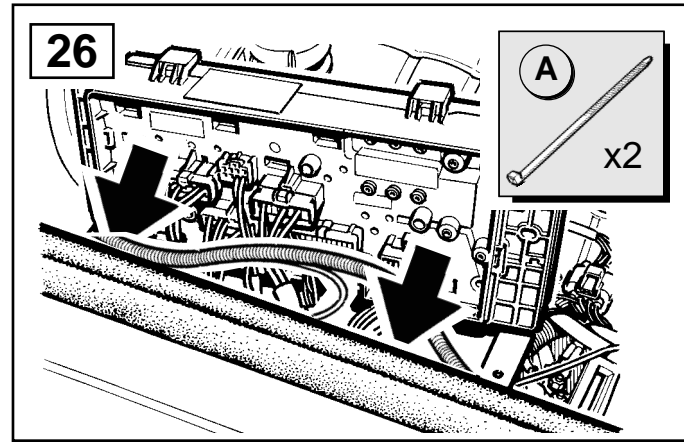
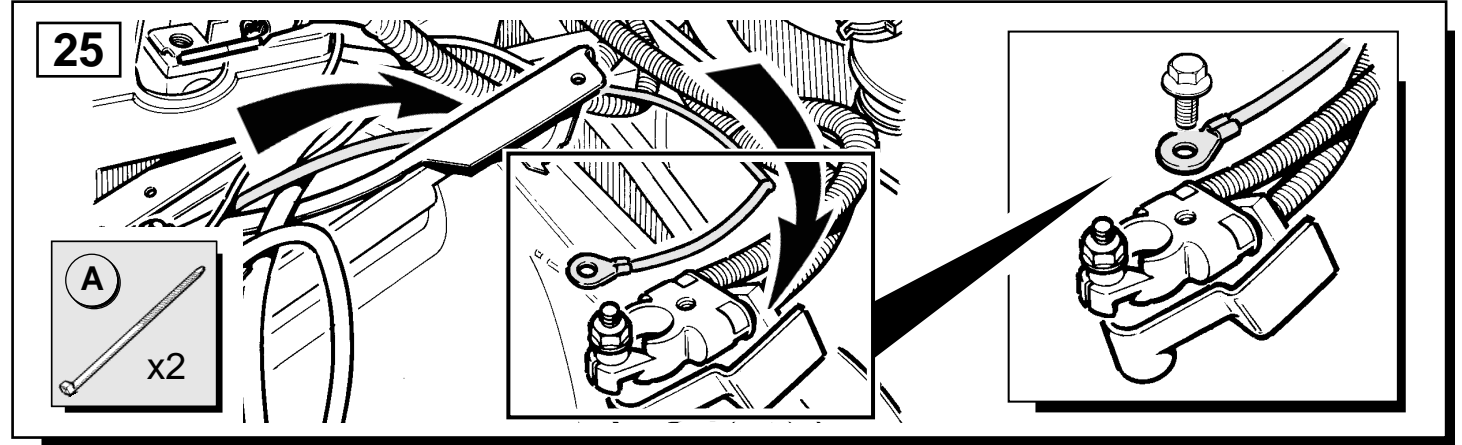
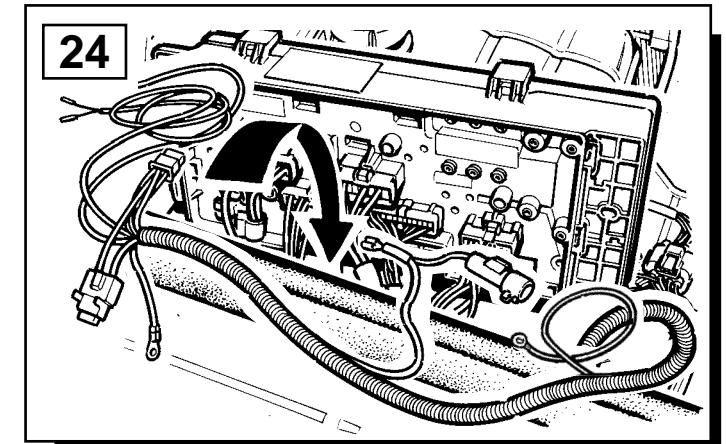
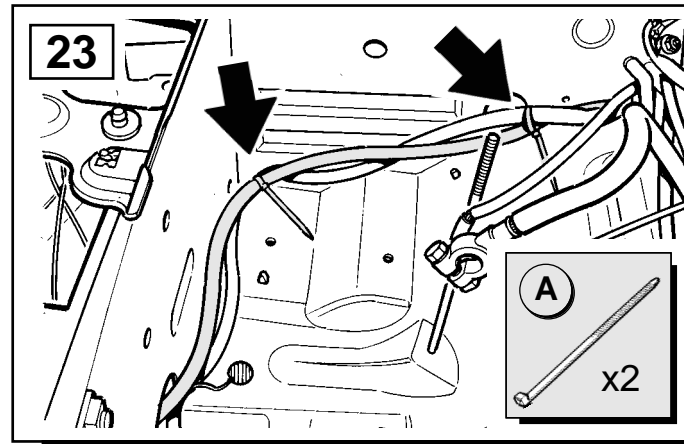
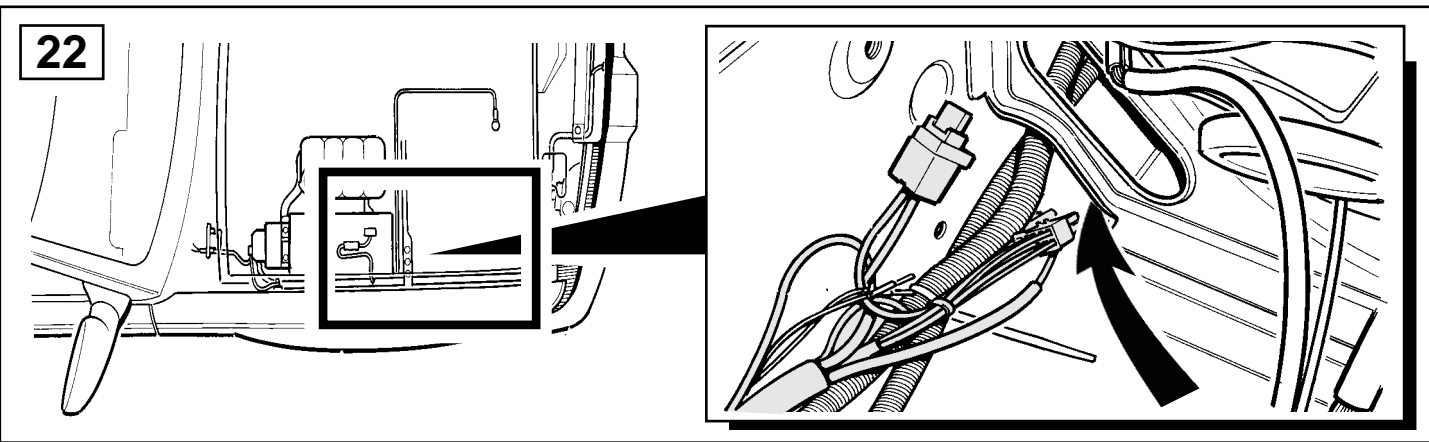
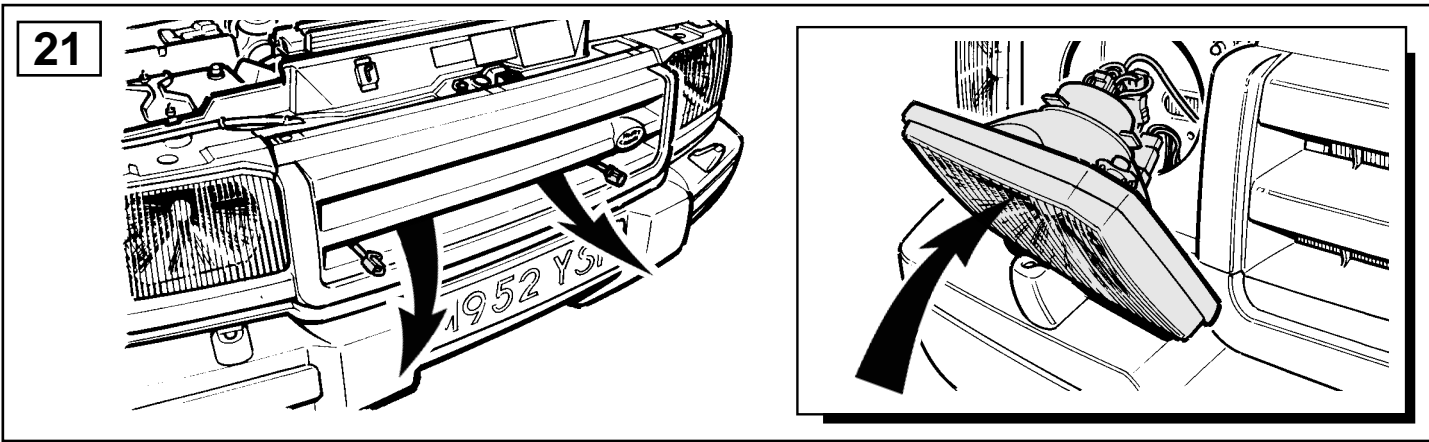
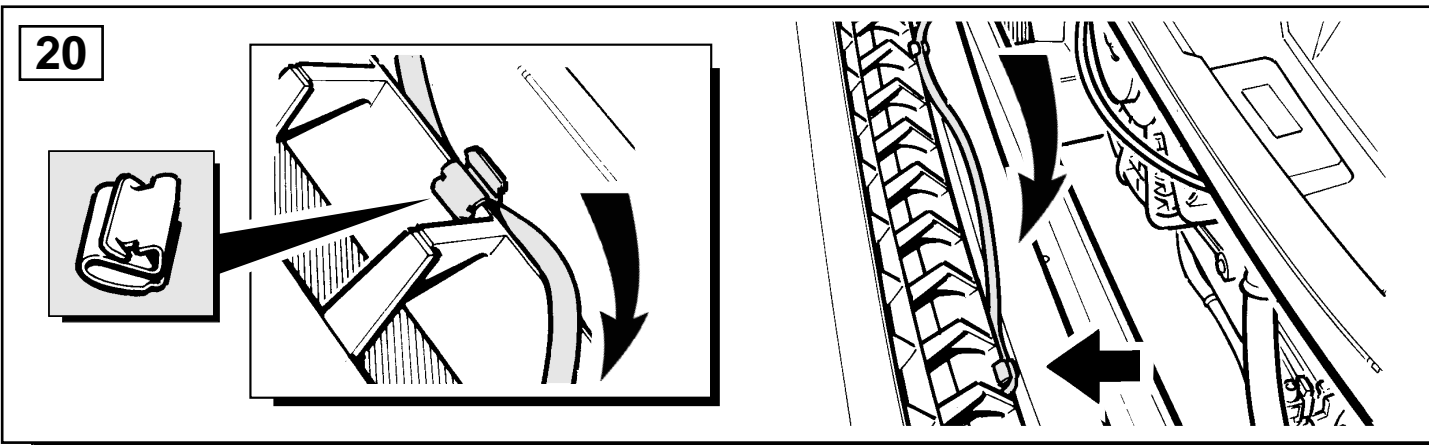
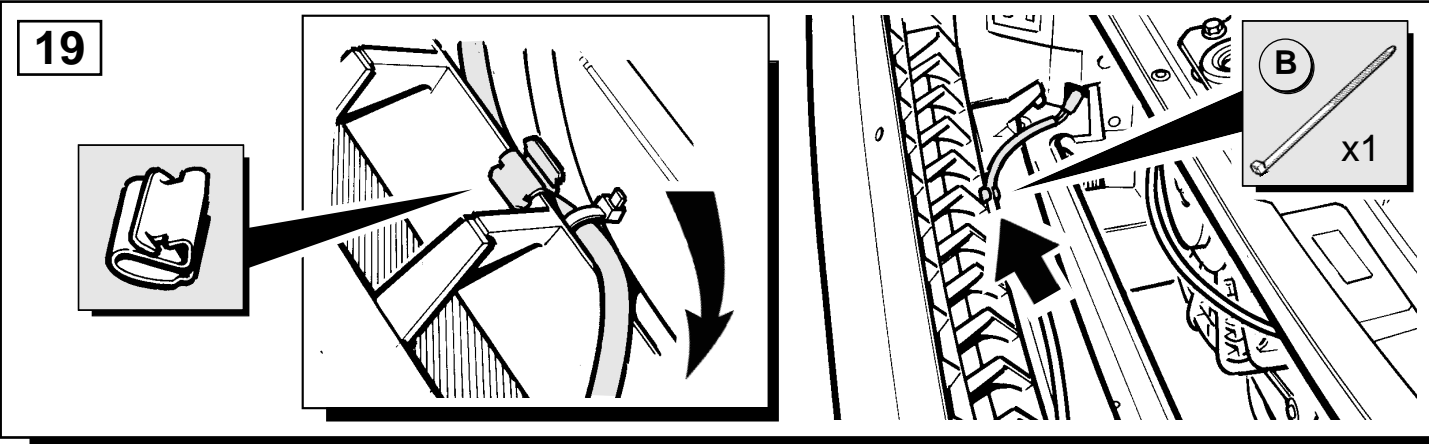

29

- (GB)** Green/White
- (D)** Grün/Weiß
- (F)** Vert/Blanc
- (I)** Vert/Blanco
- (E)** Verde/Blanco
- (P)** Verde/Branco
- (NL)** Groen/Wit
- (GR)** Πράσινο/Λευκό
- (H)** グリーン / ホワイト

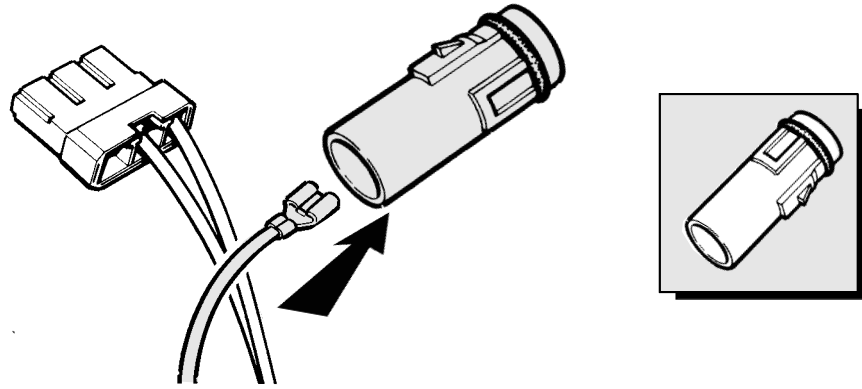

30

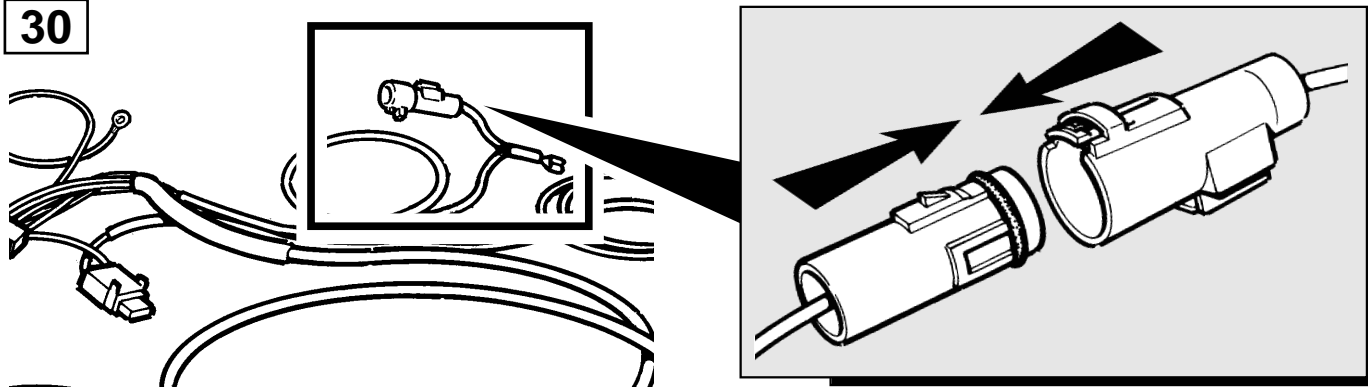

31

- (GB)** Green/White
- (D)** Grün/Weiß
- (F)** Vert/Blanc
- (I)** Vert/Blanco
- (E)** Verde/Blanco
- (P)** Verde/Branco
- (NL)** Groen/Wit
- (GR)** Πράσινο/Λευκό
- (H)** グリーン / ホワイト

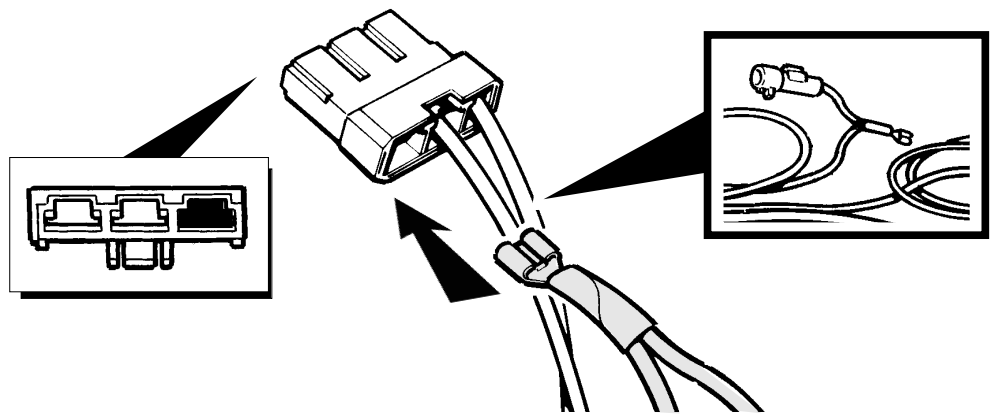

32

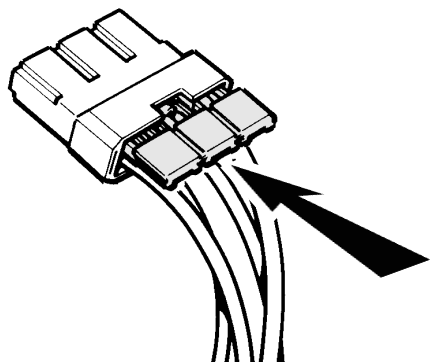

33

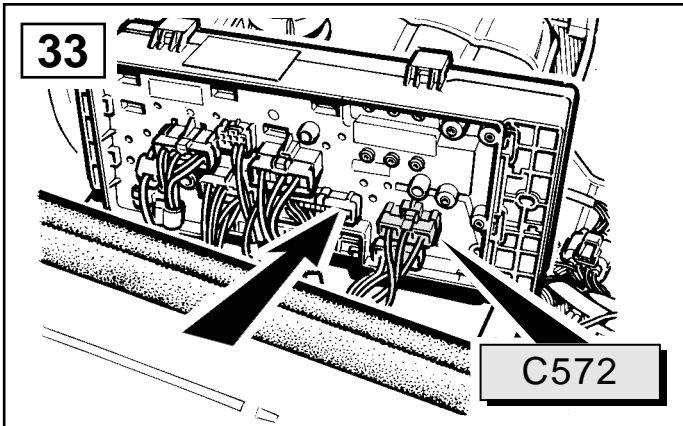

34

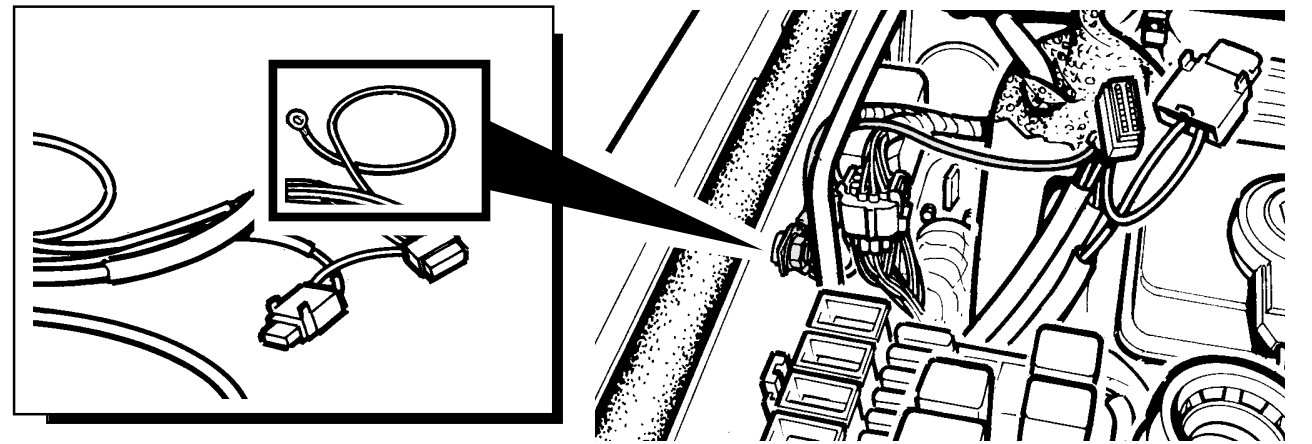

A

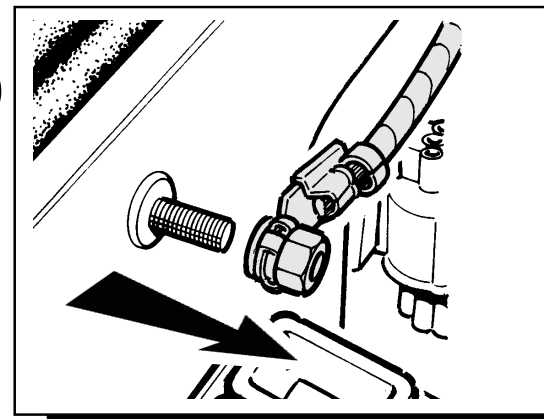

B

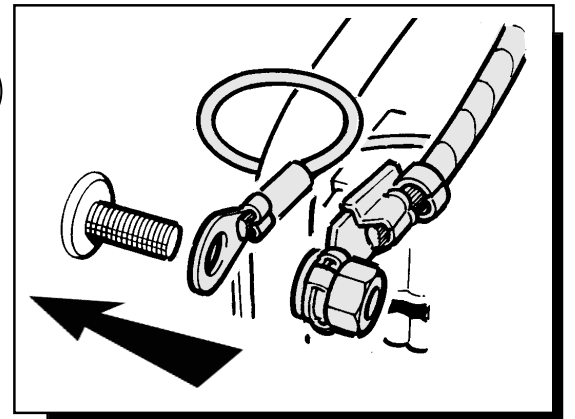

35

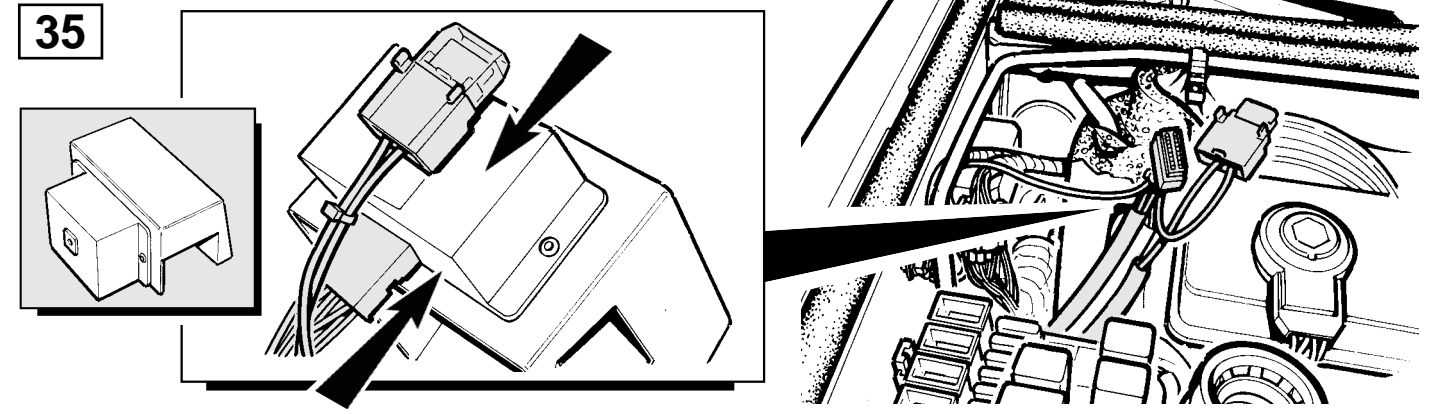

36

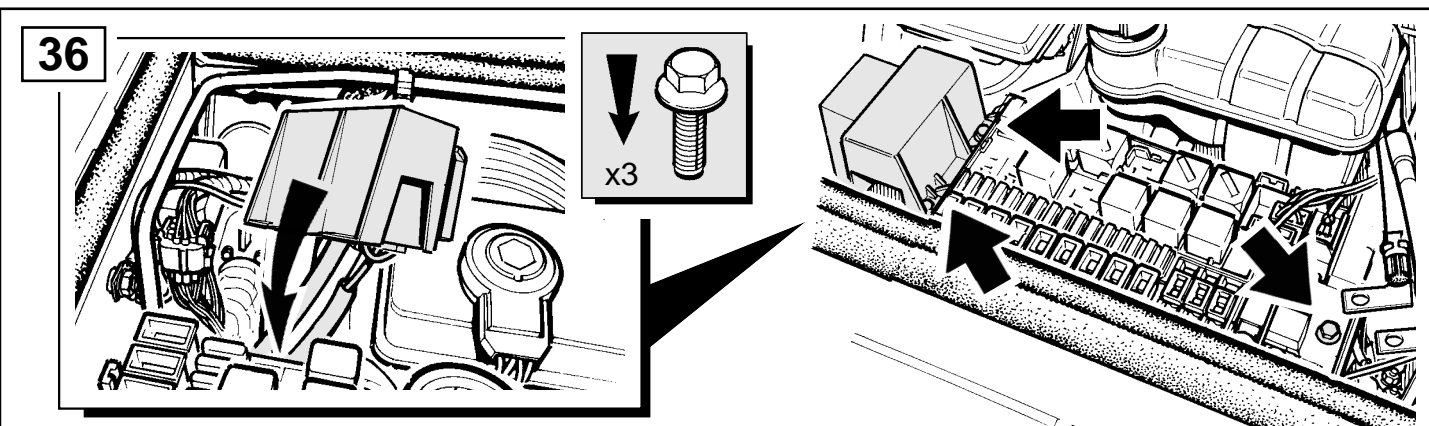

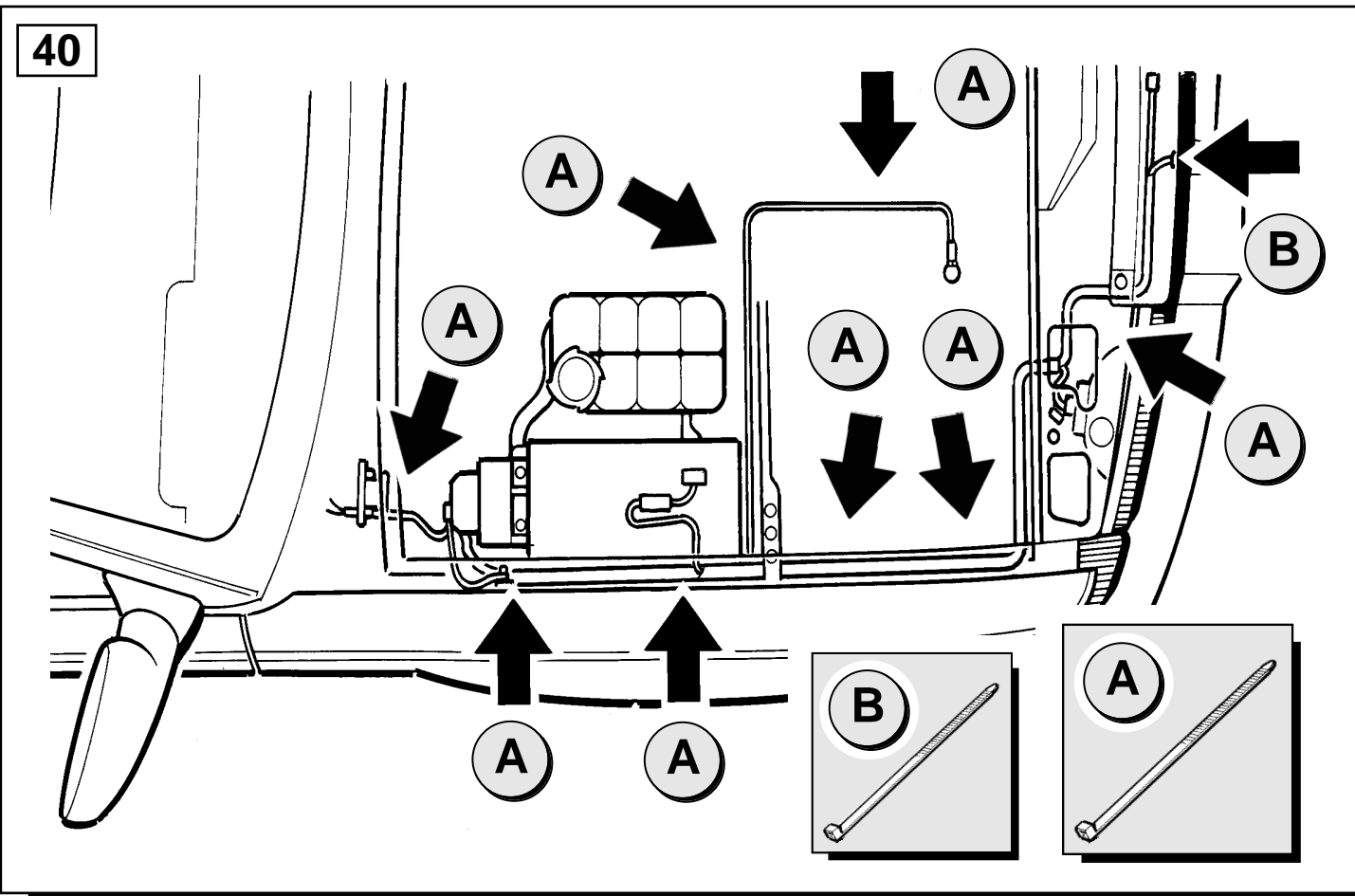
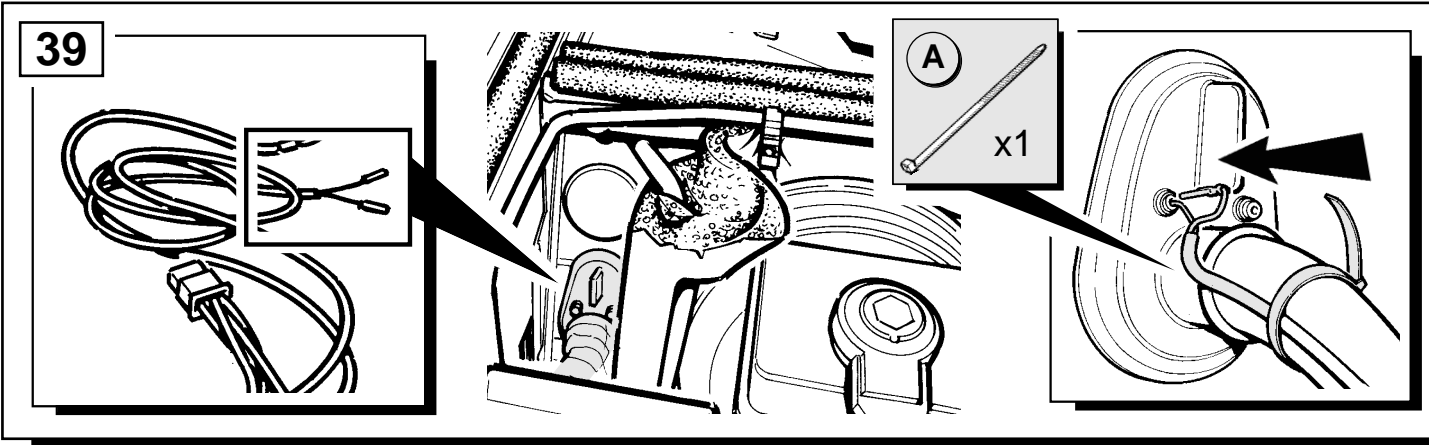
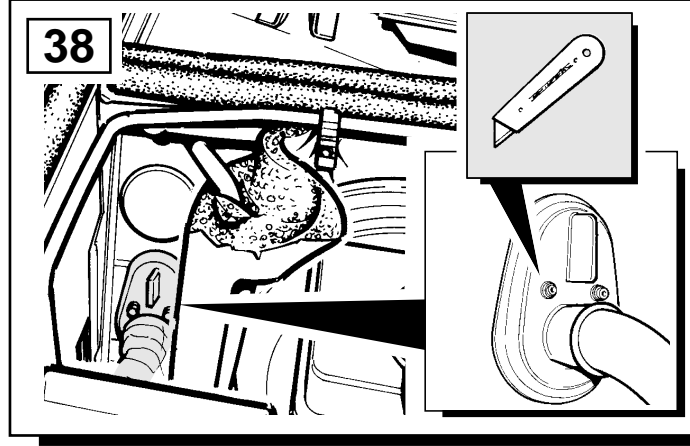
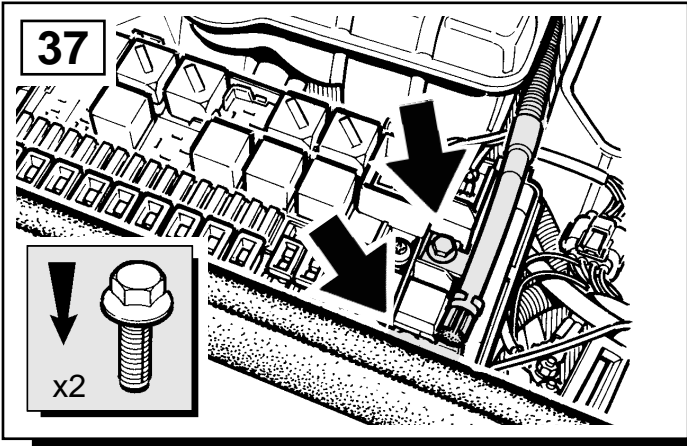

- (GB) RIGHT HAND DRIVE
- (D) RECHTSSTEUERUNG
- (F) CONDUITE A DROITE
- (I) VOLANTE A LA DERECHA
- (E) GUIDA A DESTRA
- (P) DIRECÇÃO À DIREITA
- (NL) RECHTSGESTUURDE VERSIES
- (GR) ΑΡΙΣΤΕΡΟΤΙΜΟΝΟ
- (日) 右ハンドル

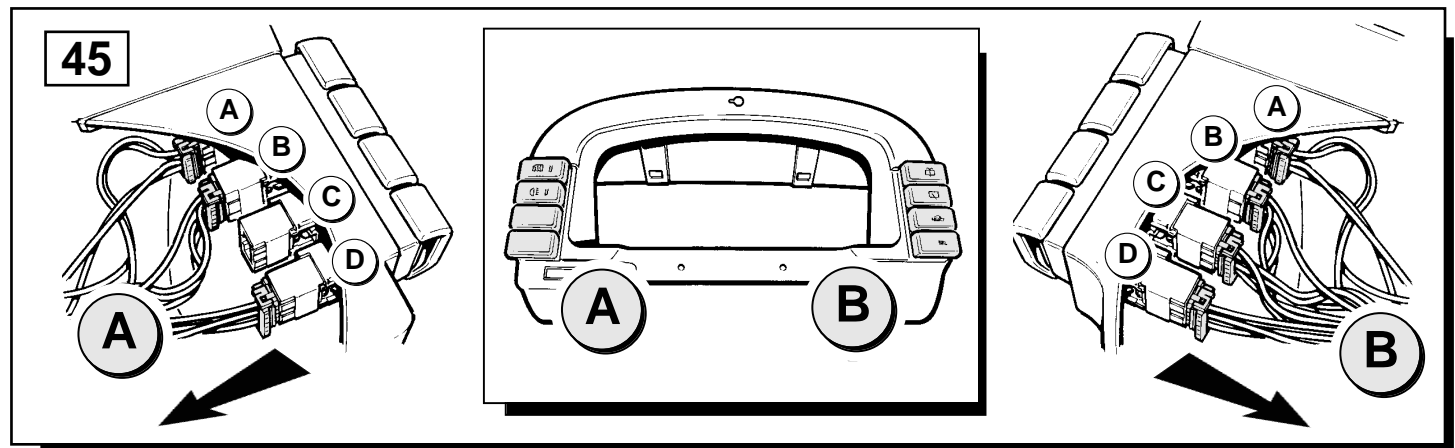
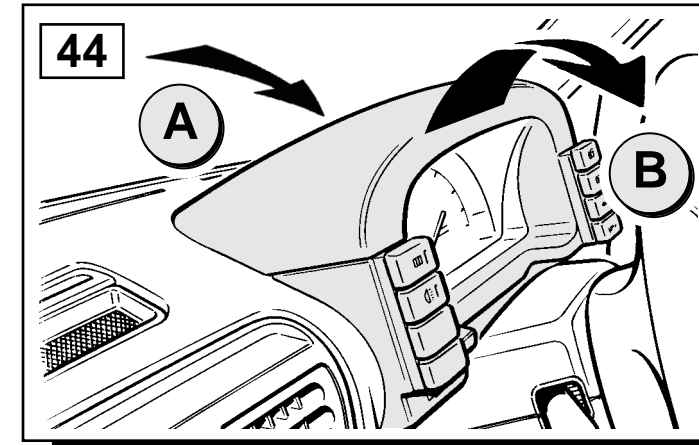
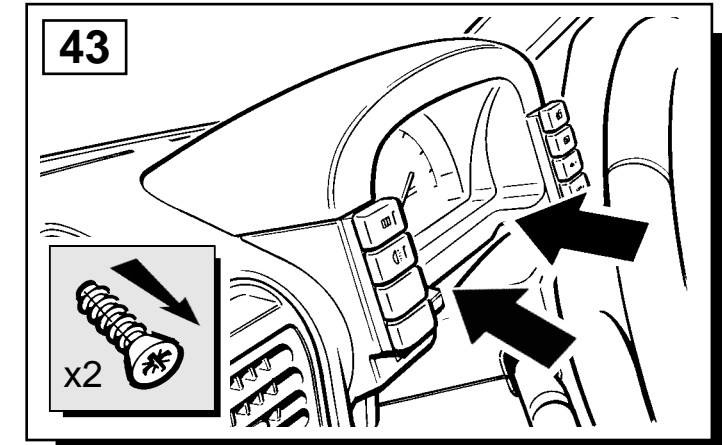
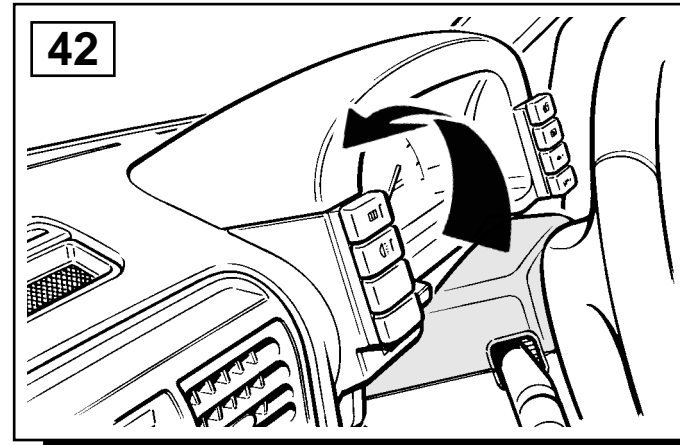
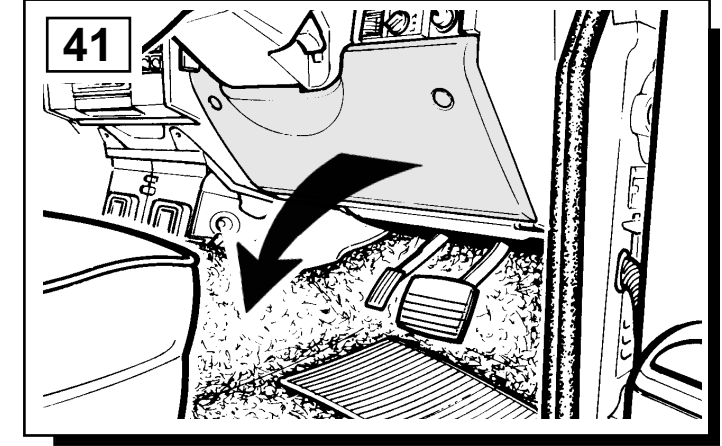

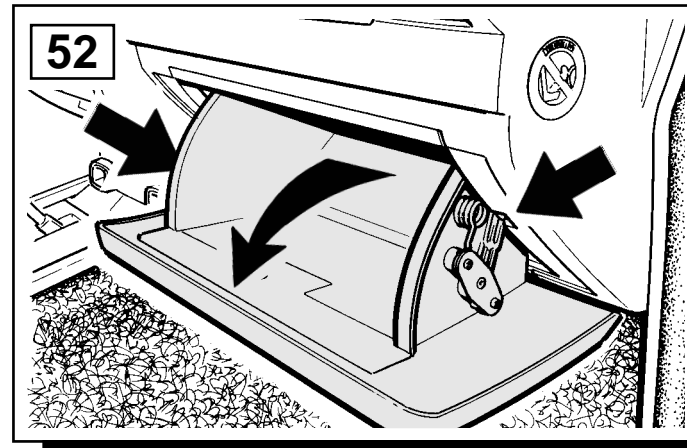
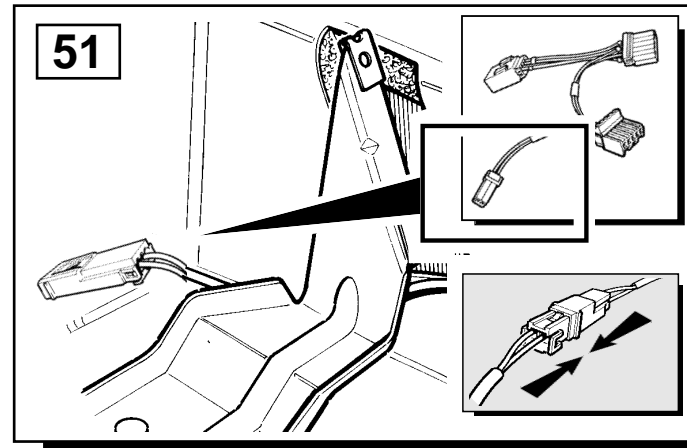
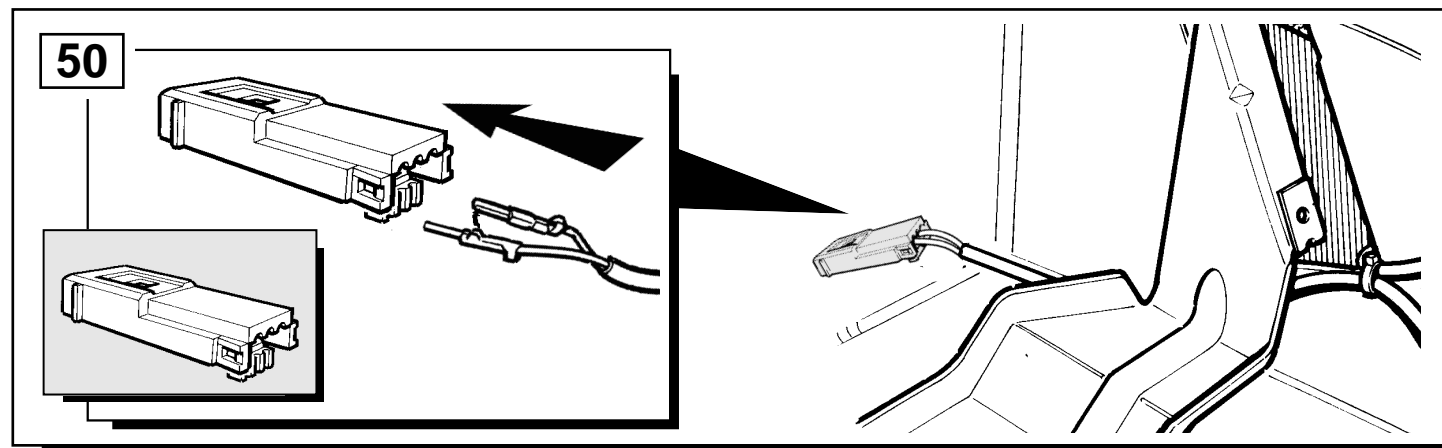
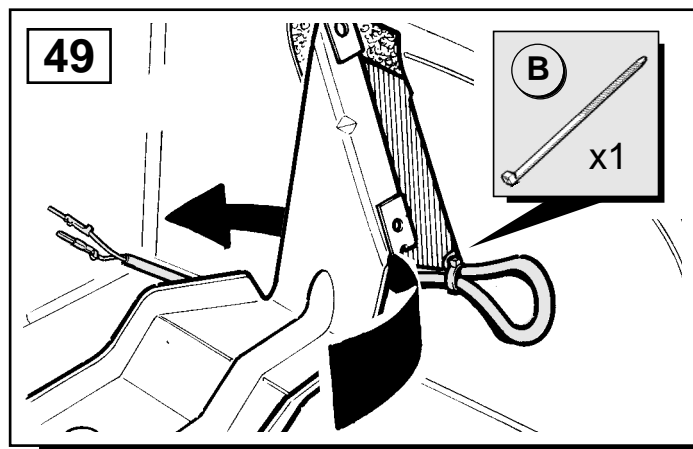
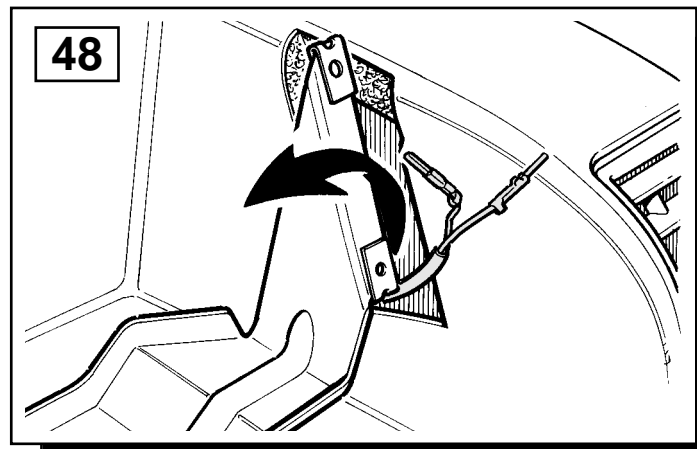
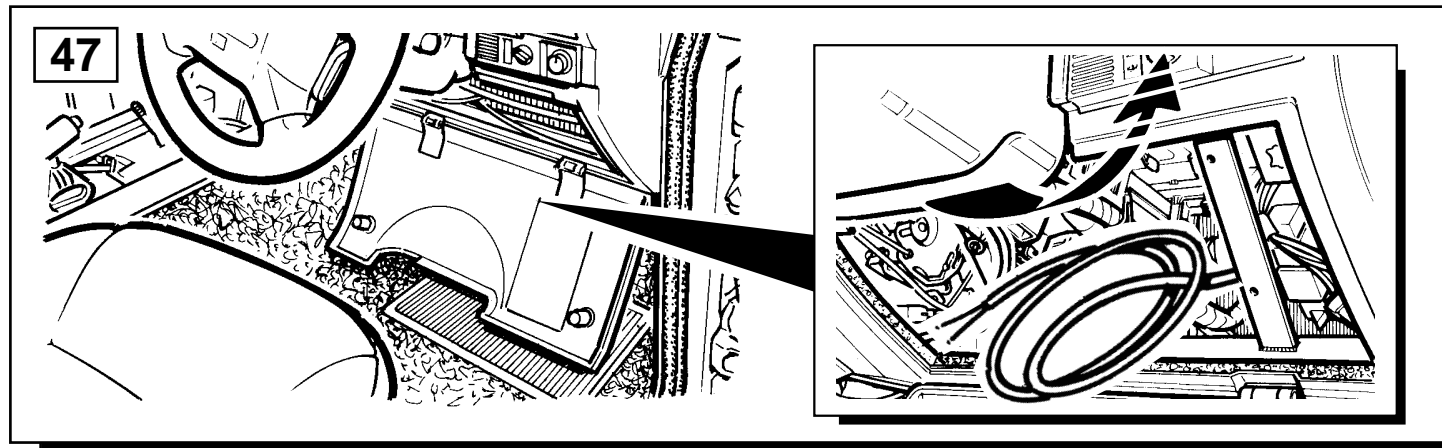
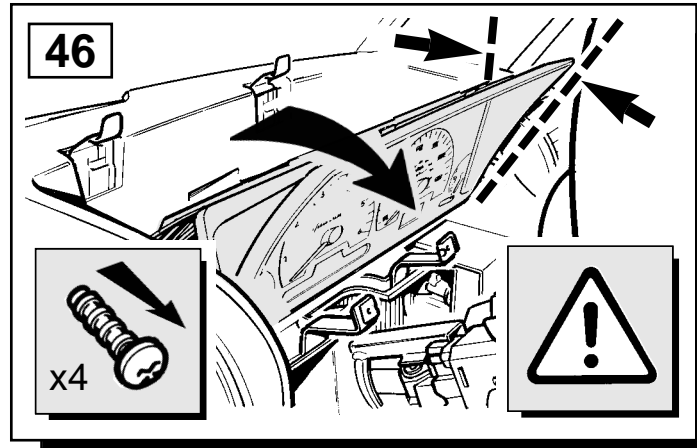

- (GB) LEFT HAND DRIVE
- (D) LINKSSSTEUERU
- (F) CONDUITE A GAUCHE
- (I) VOLANTE A LA IZQUIERDA
- (E) GUIDA A SINISTRA
- (P) DIRECÇÃO À ESQUERDA
- (NL) LINKSGESTUURDE VERSIES
- (GR) ΔΕΞΙΟΤΙΜΟΝΟ
- (日) 左ハンドル

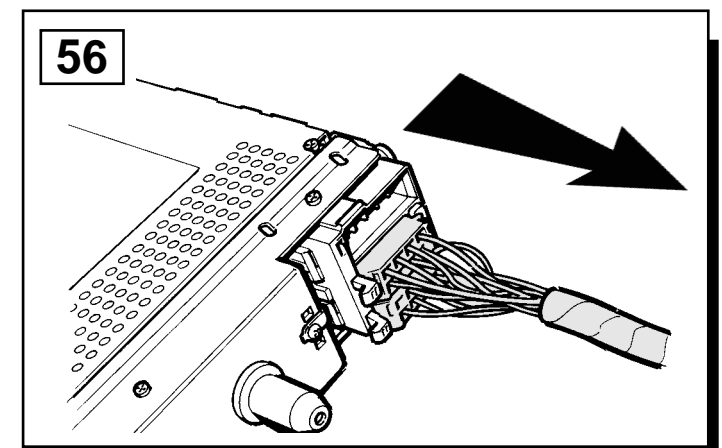
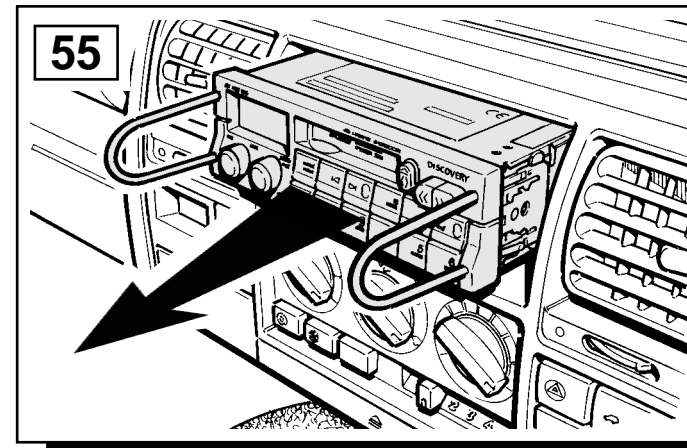
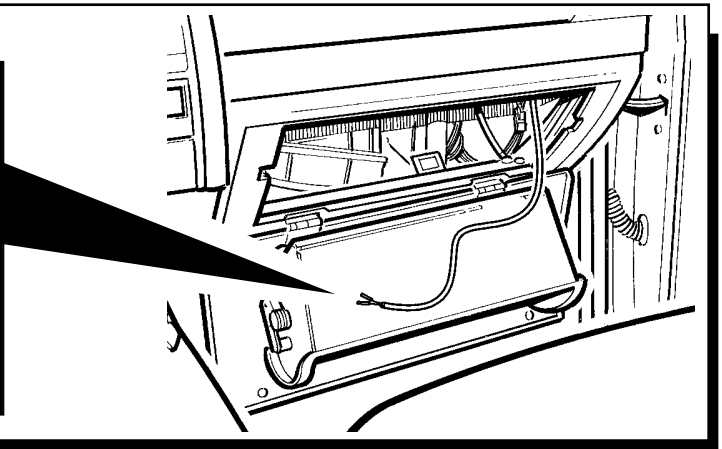
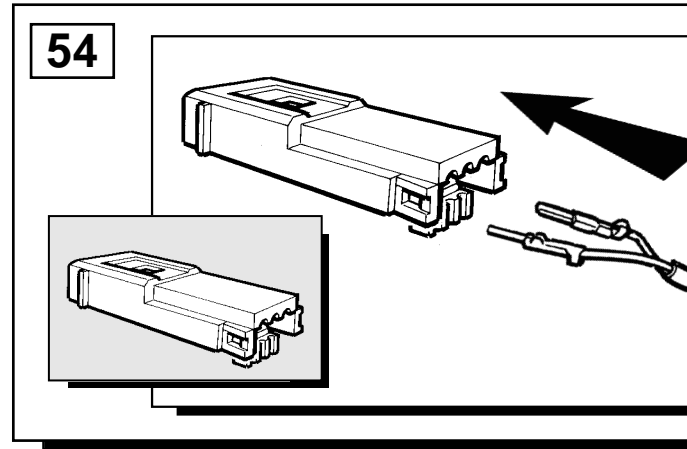
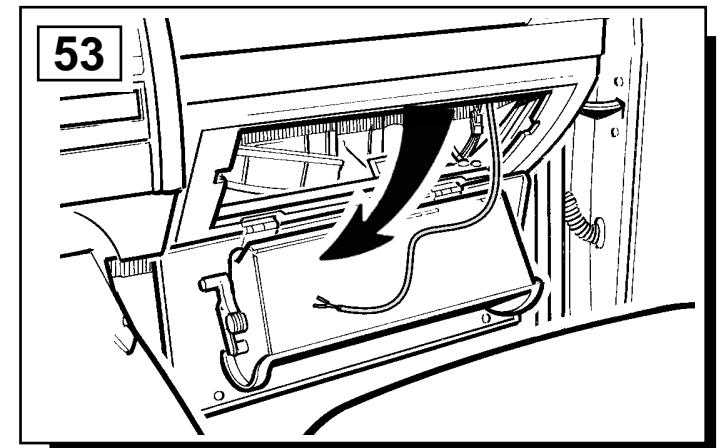

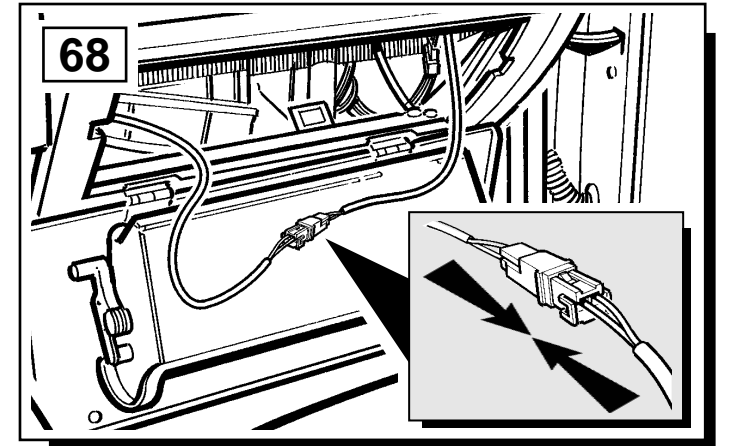
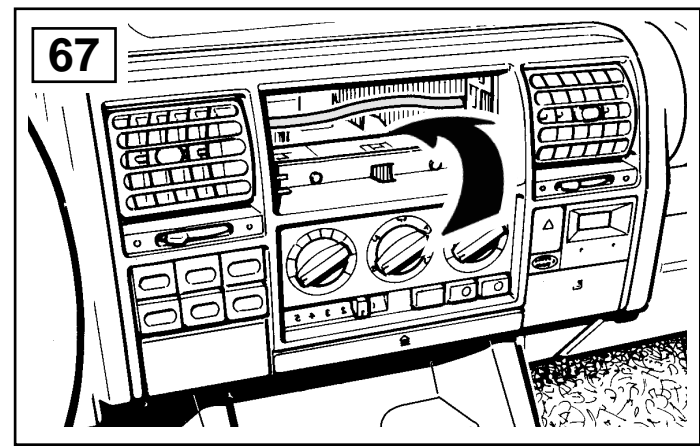
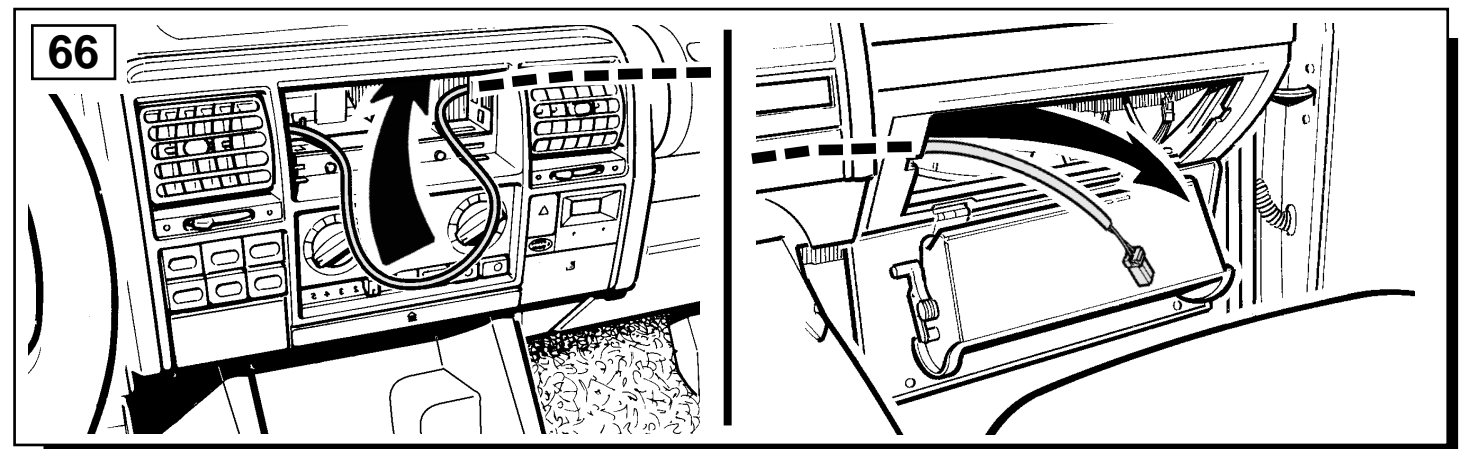
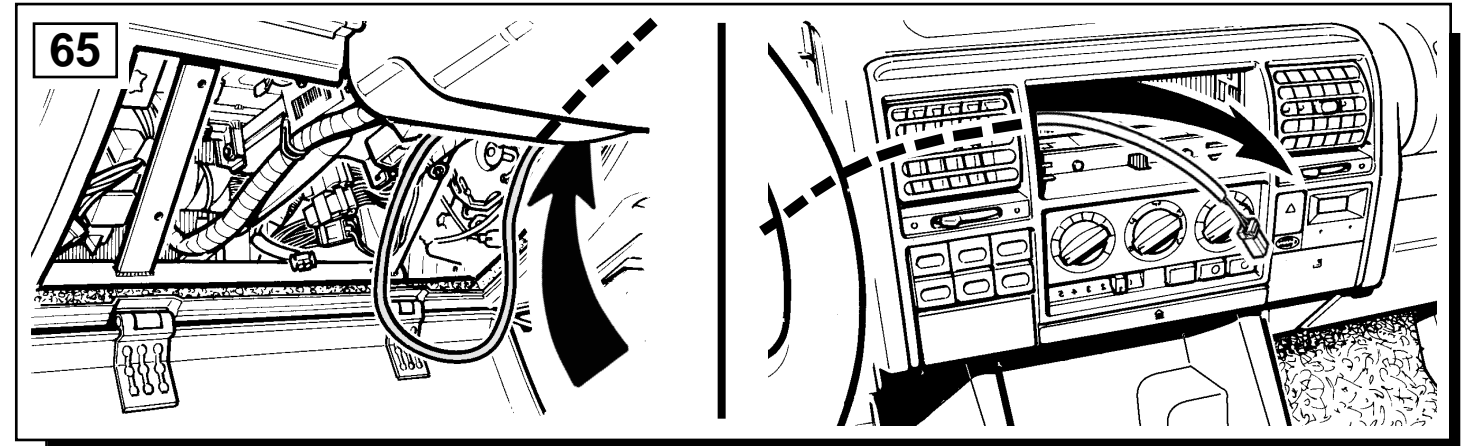
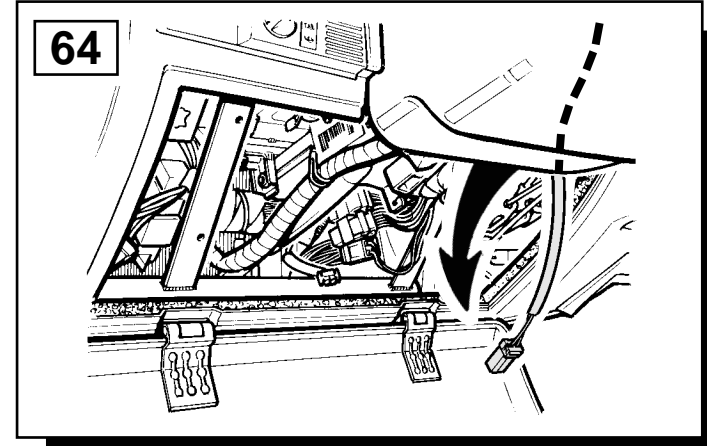
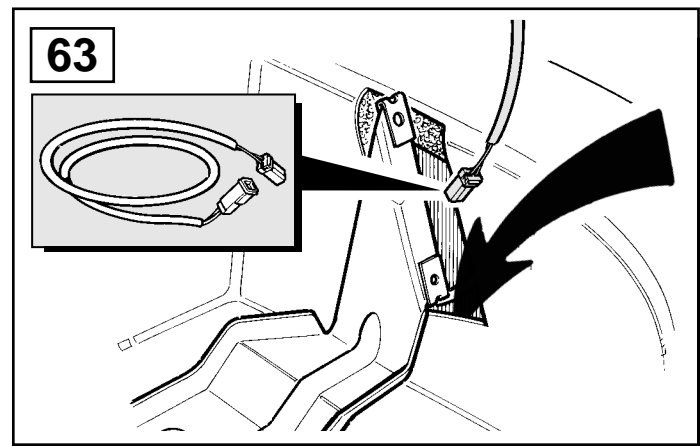
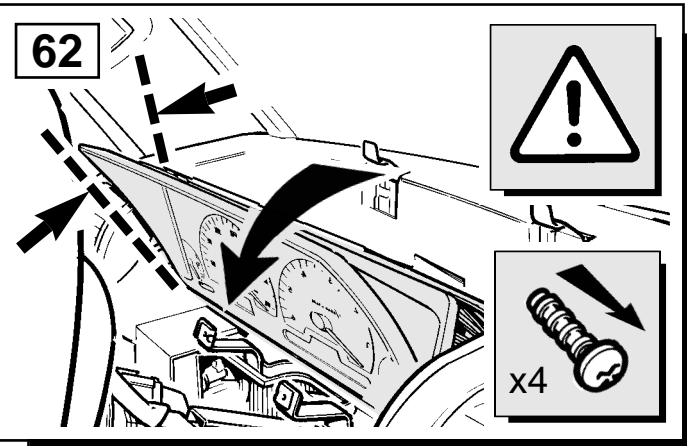
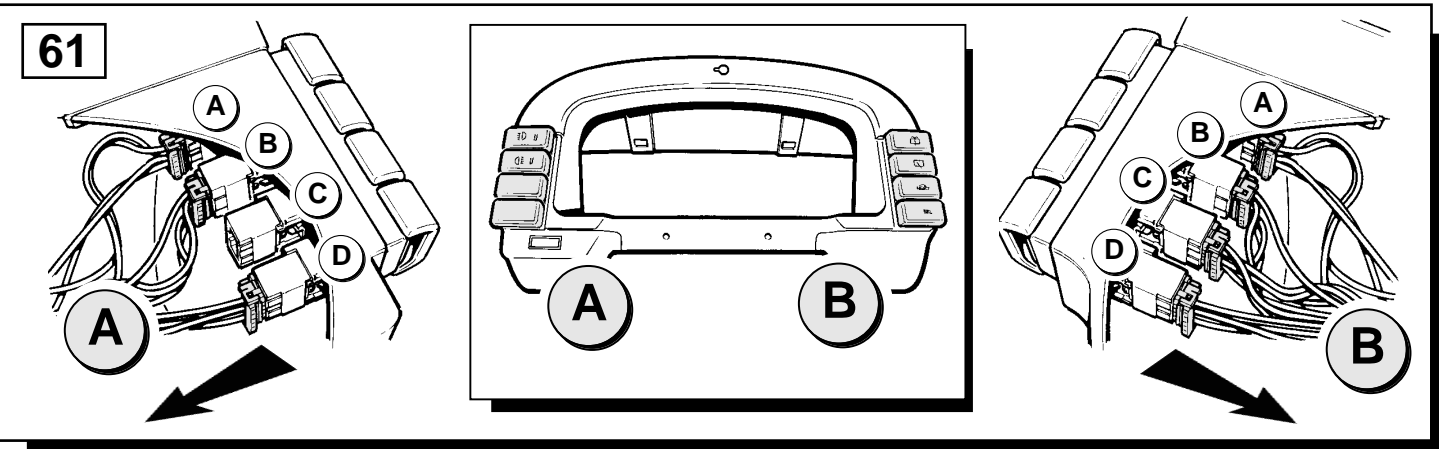
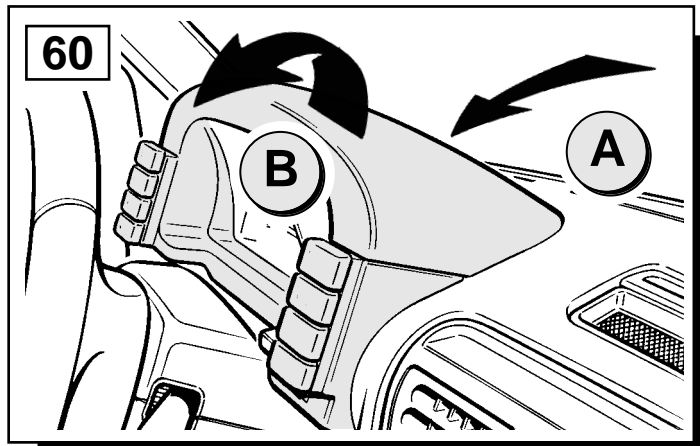
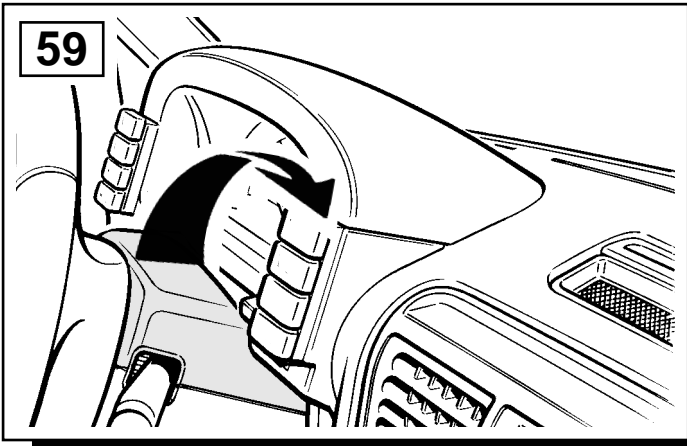
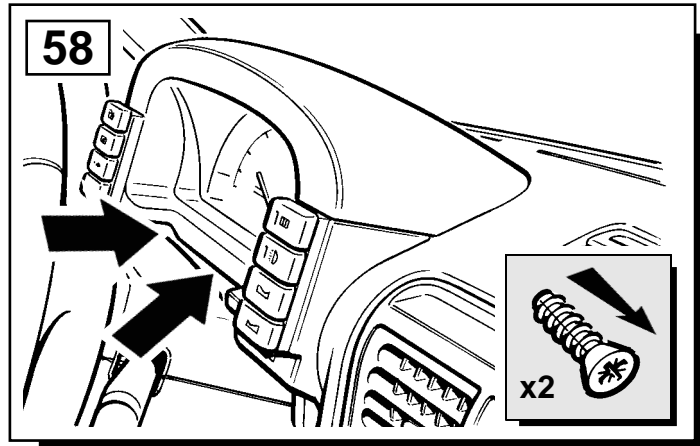
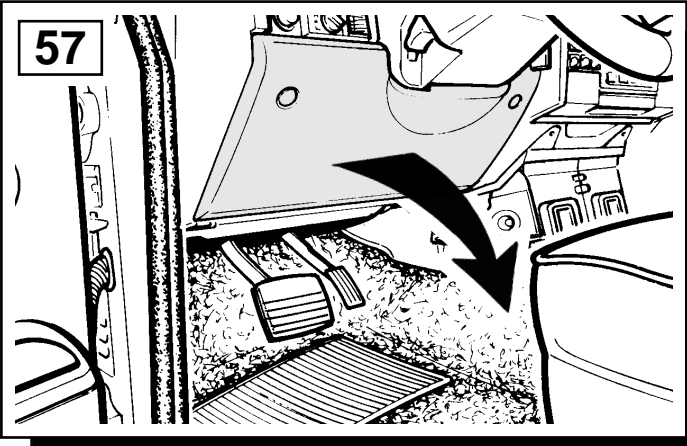

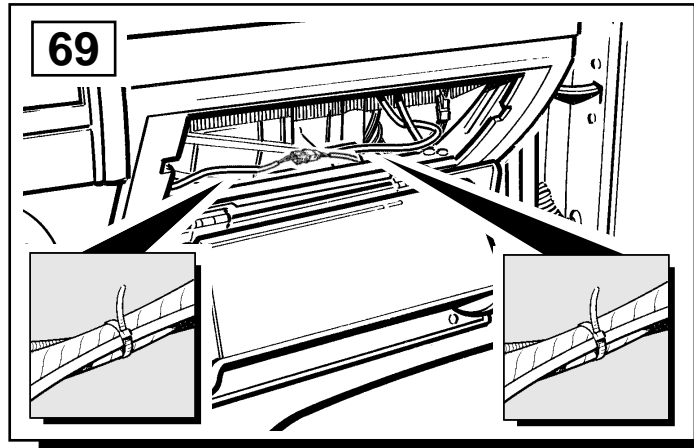

- GB** RIGHT HAND DRIVE / LEFT HAND DRIVE
- D** RECHTSSTEUERUNG / LINKSSTEUERU
- F** CONDUITE A DROITE / CONDUITE A GAUCHE
- I** VOLANTE A LA DERECHA / VOLANTE A LA IZQUIERDA
- E** GUIDA A DESTRA / GUIDA A SINISTRA
- P** DIRECÇÃO À DIREITA / DIRECÇÃO À ESQUERDA
- NL** RECHTSGESTUURDE VERSIES / LINKSGESTUURDE VERSIES
- GR** ΑΡΙΣΤΕΠΟΤΙΜΟΝΟ / ΛΙΝΚΣΓΕΣΤΟΥΡΔΕ ΒΕΡΣΙΕΣ
- 日** 右ハンドル / 左ハンドル

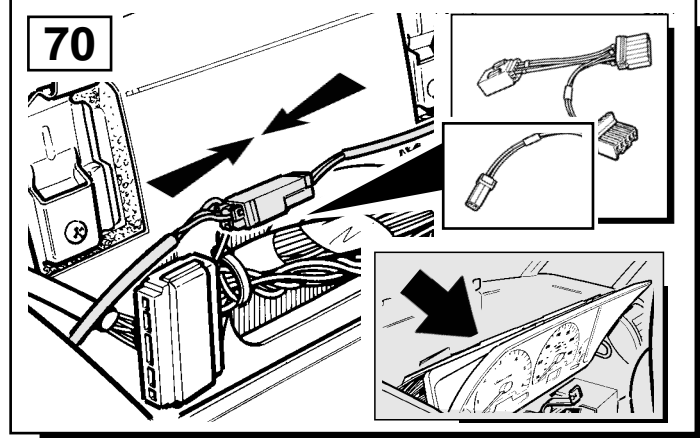

| A | B | C | D |
|---------------------------|------------------|--------------------------|-------------------------|
| GB Red/Yellow | GB Black | GB Red/Brown | GB Blue/Purple |
| D Rot/Gelb | D Schwarz | D Rot/Braun | D Blau/Violette |
| F Rouge/Jaune | F Noir | F Rouge/Brun | F Bleu/Violet |
| I Rosse/Giallo | I Nero | I Rosse/Bruno | I Azzuro/Porpora |
| E Rojo/Amarillo | E Negro | E Rojo/Marrón | E Azul/Rojo |
| P Vermelho/Amarelo | P Preto | P Vermelho/Marrom | P Azul/Roxo |
| NL Rood/Geel | NL Zwart | NL Rood/Bruin | NL Blauw/Paars |
| GR Κόκκινο/Κίτρινο | GR Μαύρο | GR Κόκκινο/Καφέ | GR Μπλε/Μωβ |
| 日 レッド / イエロー | 日 ブラック | 日 レッド / 茶色 | 日 ブルー / パープル |

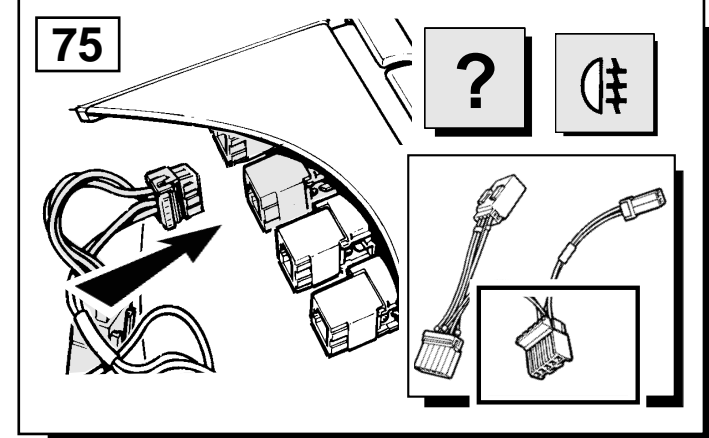
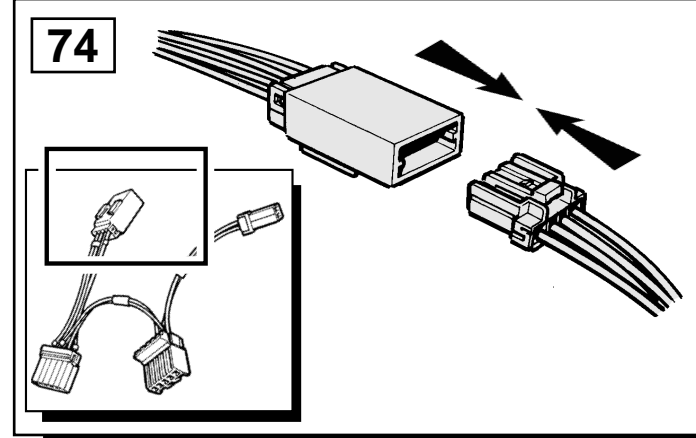

- GB** Blue
- D** Blau
- F** Bleu
- I** Azzuro
- E** Azul
- P** Azul
- NL** Blauw
- GR** Μπλε
- 日** ブルー

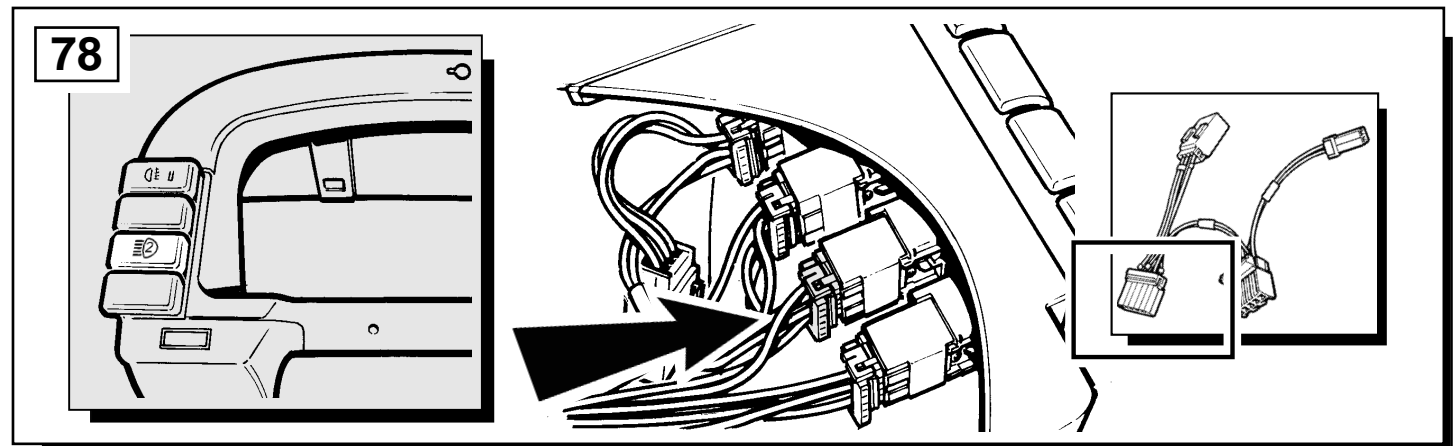
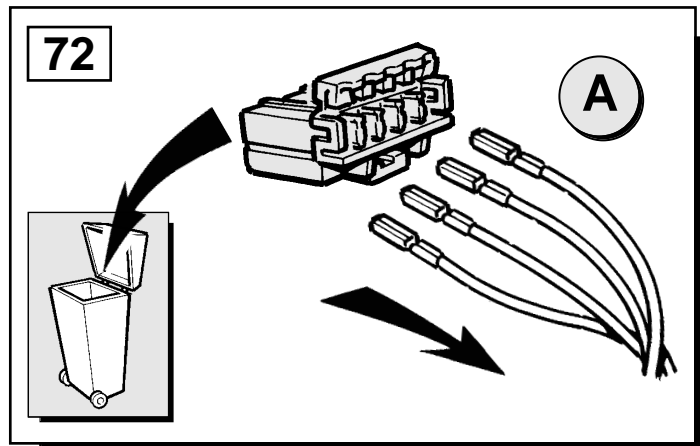
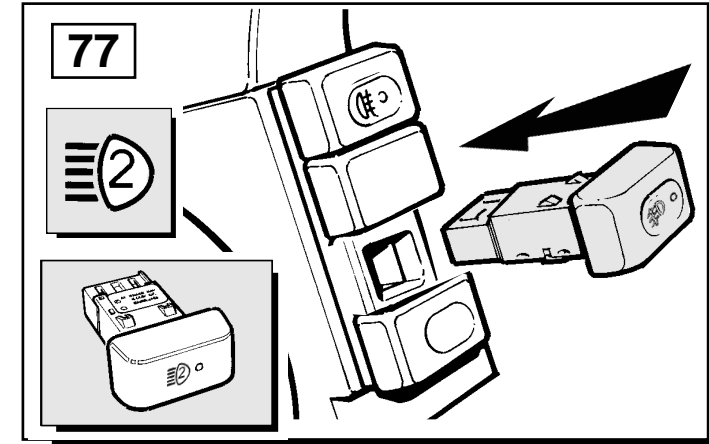
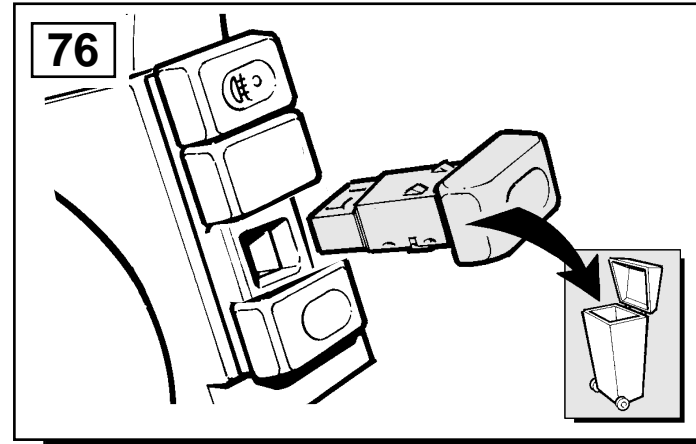

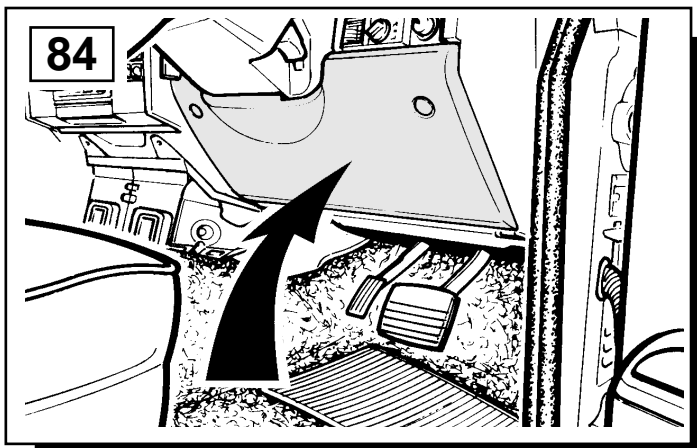
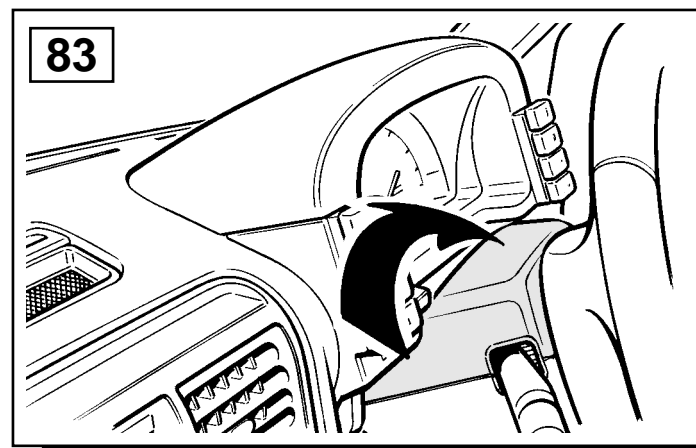
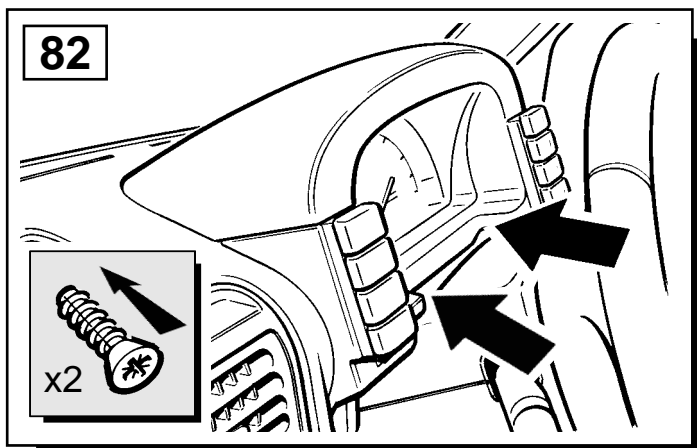
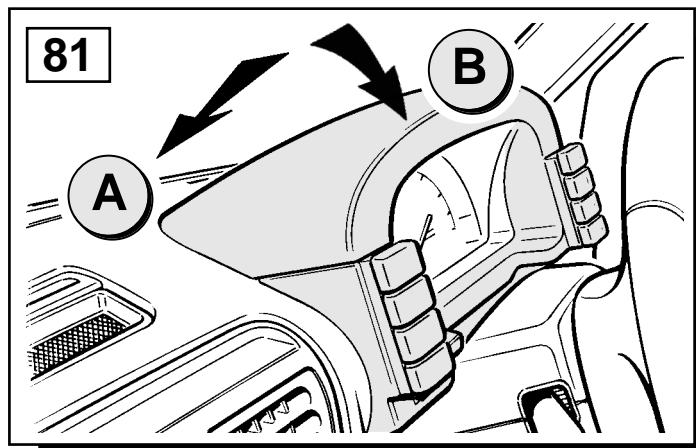
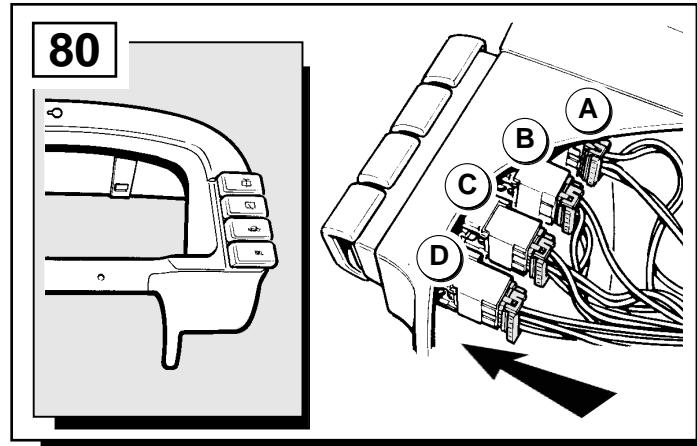
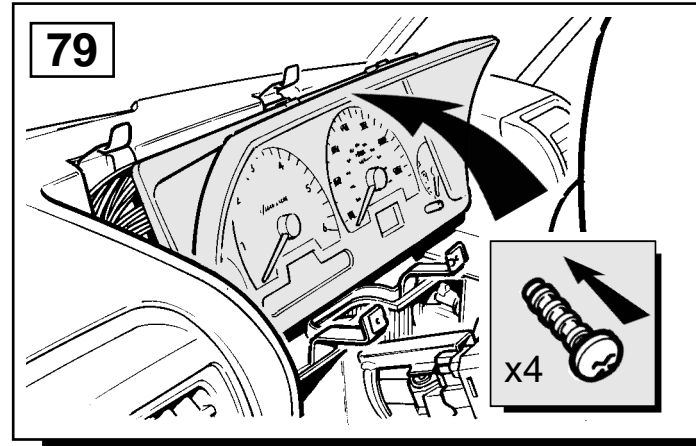

- (GB) LEFT HAND DRIVE
- (D) LINKSSSTEUERU
- (F) CONDUITE A GAUCHE
- (I) VOLANTE A LA IZQUIERDA
- (E) GUIDA A SINISTRA
- (P) DIRECÇÃO À ESQUERDA
- (NL) LINKSGESTUURDE VERSIES
- (GR) ΔΕΞΙΟΤΙΜΟΝΟ
- (日) 左ハンドル

