



FITTING INSTRUCTION
Dog Guard

EINBAUANLEITUNG
Hundegitter

INSTRUCTION DE MONTAGE
Grille protectrice pour chien

ISTRUZIONI PER L'USO
Riparo per cani

INSTRUCCIONES DE MONTAJE
Defensa para perros

INSTRUÇÕES DE MONTAGEM
Separador para cães

MONTAGEHANDLEIDING
Separador para cães

ΟΔΗΓΙΑ ΤΟΠΟΘΕΤΗΣΗΣ
Προστατευτικό Χώρισμα για Σκύλο

取付用マニュアル
ドッグ ガード

PART No. STC 50082AA / STC 50323 Issue No. 1

DISCOVERY



ACCESSORIES

WARNING

Accessories which are not properly fitted can be dangerous. Read the instructions carefully prior to fitting. Whilst fitting, comply with the instructions at all times. If in doubt, contact your nearest Land Rover Dealer.

ACHTUNG!

Nicht sachgemäß montiertes Zubehör kann gefährlich sein. Lesen Sie die Montageanleitung sorgfältig, bevor Sie das Teil montieren. Halten Sie sich bei der Montage an die Anleitung. Bei Unsicherheiten wenden Sie sich bitte an Ihren Land Rover Händler.

AVERTISSEMENT

Les accessoires qui ne sont pas correctement montés risquent d'être dangereux. Veuillez lire soigneusement les instructions avant d'effectuer la pose. Respectez toujours les instructions en cours de pose. En cas de doute, consultez votre concessionnaire Land Rover local.

AVVERTENZA

Gli accessori non sistemati come previsto possono essere pericolosi. Leggere attentamente le istruzioni prima del fissaggio. Durante il montaggio seguire sempre le relative istruzioni. In caso di dubbio rivolgersi al più vicino concessionario della Land Rover.

AVISO

Aquellos accesorios que no hayan sido ajustados debidamente pueden resultar peligrosos. Lea las instrucciones detenidamente antes de iniciar el montaje. Durante el montaje siga las instrucciones en todo momento. En caso de duda póngase en contacto con su Concesionario de Land Rover.

ADVERTÊNCIA!

Os Acessórios que não são montados adequadamente podem ser perigosos. Leia as instruções cuidadosamente antes de montar. Durante a montagem, obedeça as instruções todo o tempo. Se tiver alguma dúvida, contacte o Concessionário LandRover mais próximo.

WAARSHCUWING

Accessoires die niet op de juiste wijze zijn gemonteerd kunnen gevaar opleveren. Lees zorgvuldig de instructies alvorens met de montage te beginnen. Houd u tijdens de montage te allen tijde aan de instructies. Neem bij twijfel contact op met de dichtstbijzijnde Land Rover dealer.

ΠΡΟΕΙΔΟΠΟΙΗΣΗ

Τα προαιρετικά εξαρτήματα που δεν έχουν τοποθετηθεί σωστά μπορεί να είναι επικίνδυνα. Διαβάστε τις οδηγίες πριν προχωρήσετε στην τοποθέτησή τους. Κατά την τοποθέτηση, τηρείτε συνεχώς τις οδηγίες. Αν έχετε οποιαδήποτε αμφιβολία, επικοινωνήστε με τον πλησιέστερο αντιπρόσωπο της.

注意

正しく取り付けられていない部品があると、事故の原因になります。取付ける前にこのマニュアルをよくお読みください。取付けの際は必ずこのマニュアルにある指示に従ってください。何か不明な点がありましたら、お近くのランド・ローバー社のディーラーまでお問い合わせください。

FITTING INSTRUCTION No. STC 50082AA FIT

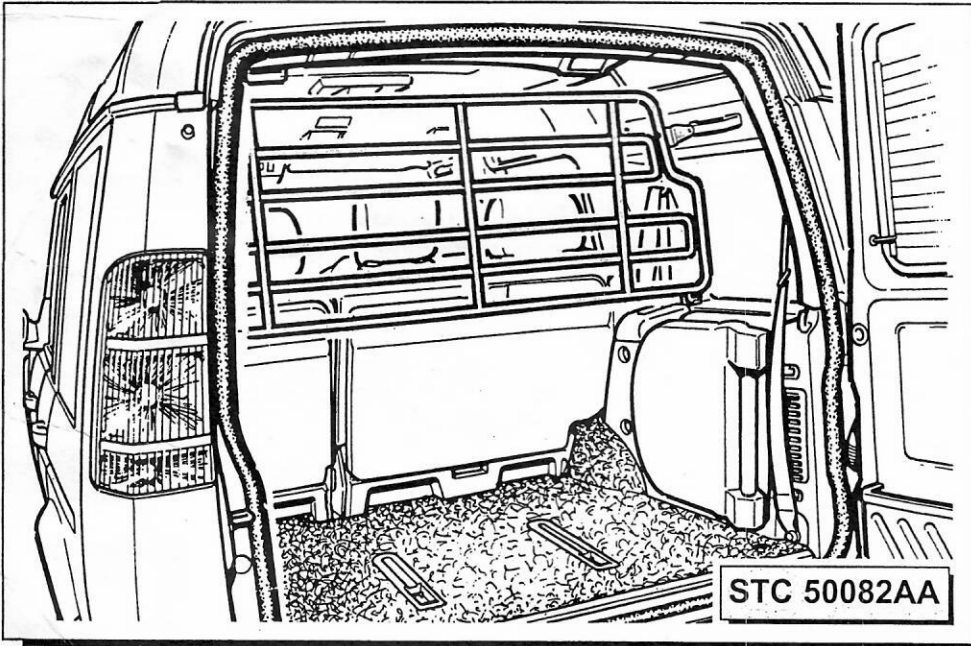
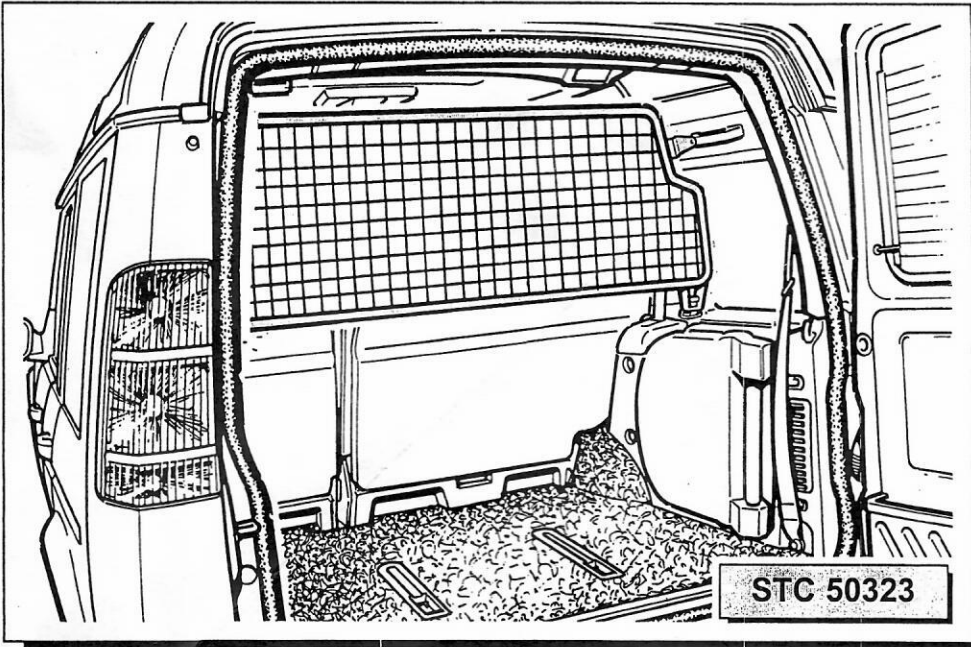

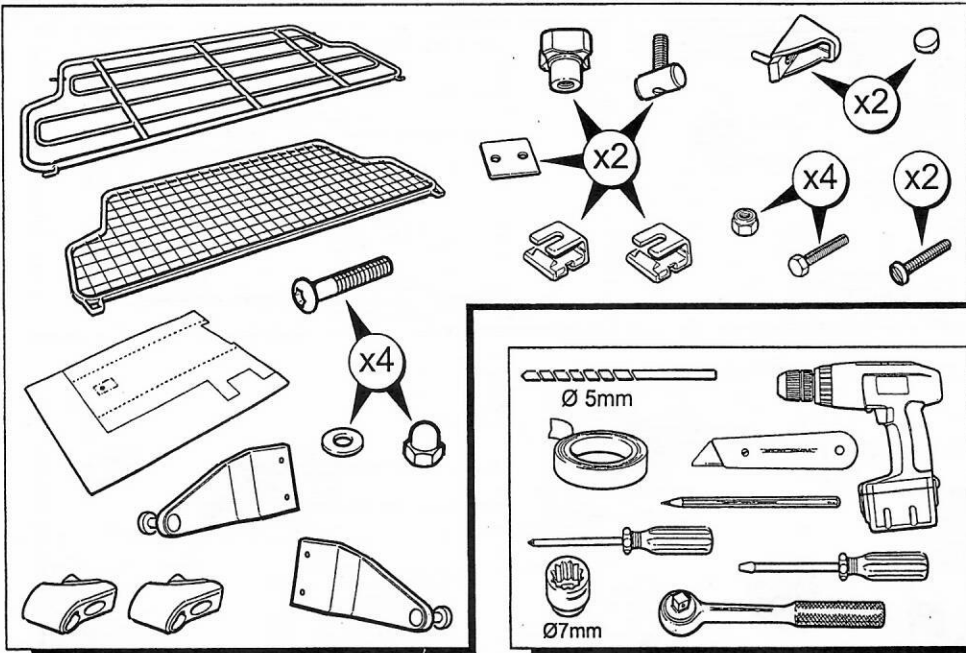
**GB**

For vehicles with handles follow instructions 1 to 3 and 28 to 44.
For vehicles without handles follow instructions 4 to 44.

D

Befolgen Sie bei Fahrzeugen mit Handgriffen die Anweisungen 1 bis 3 und 28 bis 44.
Befolgen Sie bei Fahrzeugen ohne Handgriffen die Anweisungen 4 bis 44.

F

Les véhicules avec poignées, suivre les instructions 1 à 3 & 28 à 44.
Les véhicules sans poignées, suivre les instructions 4 à 44.

I

Per i veicoli con maniglie seguire le istruzioni da 1 a 3 e da 28 a 44.
Per i veicoli senza maniglie seguire le istruzioni da 4 a 44.

E

Para vehículos con manecillas, seguir las instrucciones 1 a 3 y 28 a 44.
Para vehículos sin manecillas, seguir las instrucciones 4 a 44.

P

Para veículos com pegas, seguir as instruções de 1 a 3 e de 28 a 44.
Para veículos sem pegas, seguir as instruções de 4 a 44.

NL

Voor voertuigen met handgrepen volg instructies 1 tot 3 en 28 tot 44.
Voor voertuigen zonder handgrepen volg instructies 4 tot 44.

GR

Για οχήματα με χειρολαβές, ακολουθήστε τις οδηγίες 1 έως 3 και 28 έως 44.
Για οχήματα χωρίς χειρολαβές, ακολουθήστε τις οδηγίες 4 έως 44.

日

ハンドル付き車両については、1 から 3 および 28 から 44 の指示に従ってください。
ハンドル無し車両については、4 から 44 の指示に従ってください。

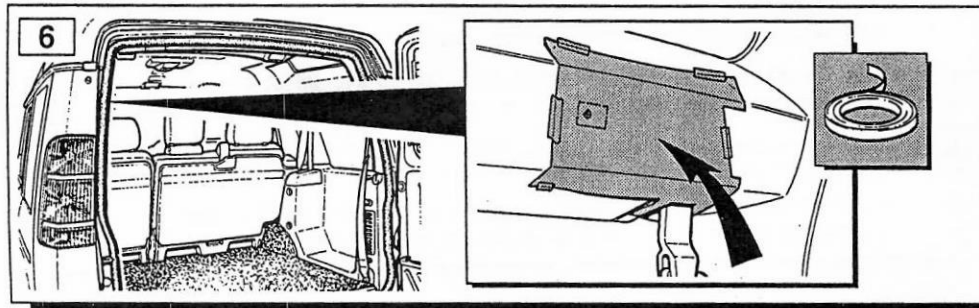
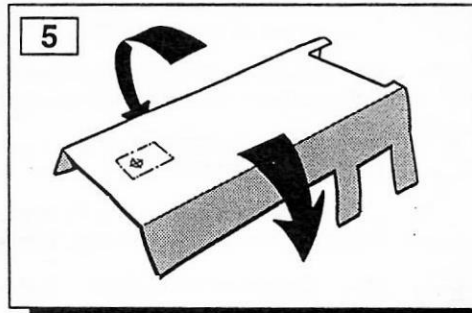
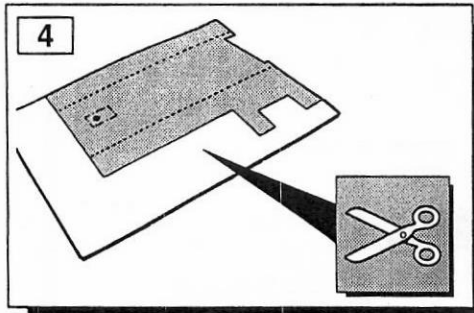
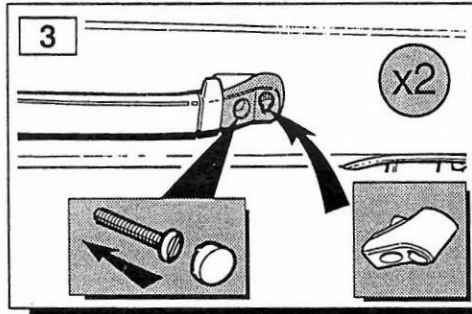
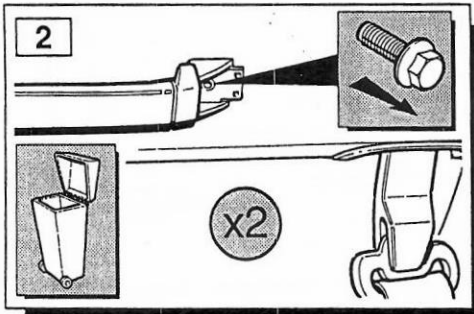
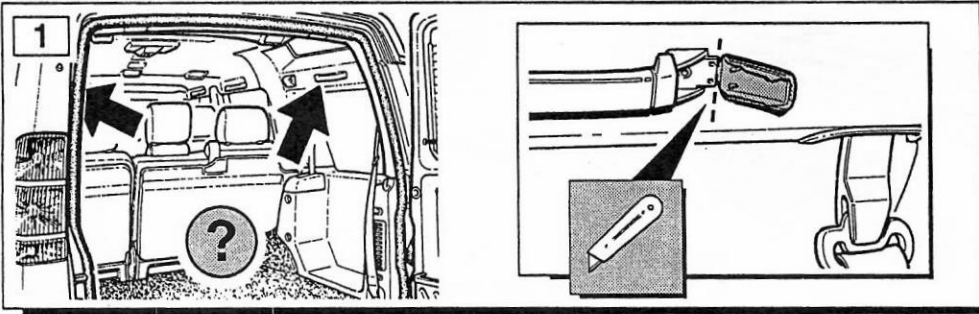

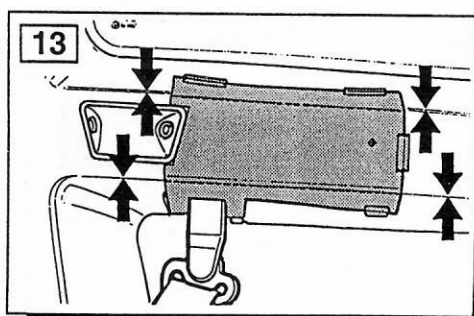
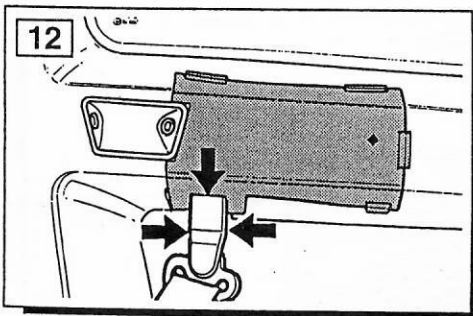
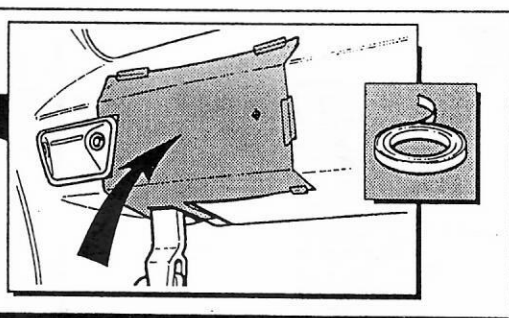
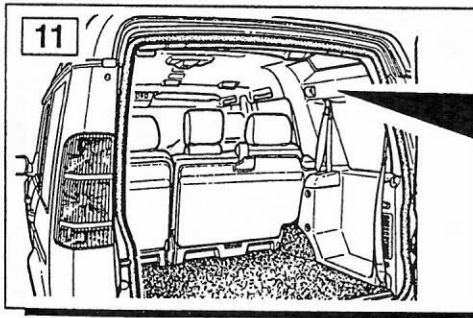
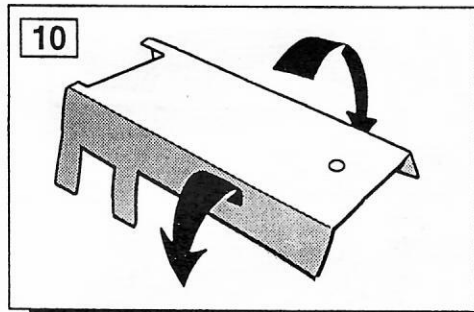
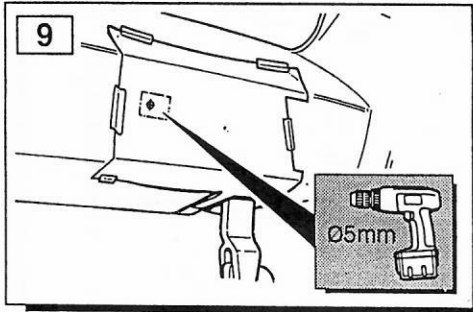
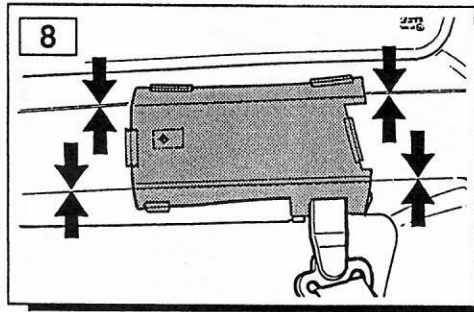
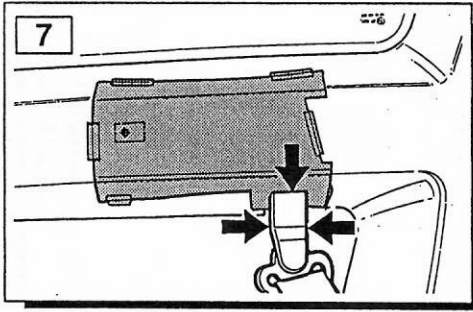

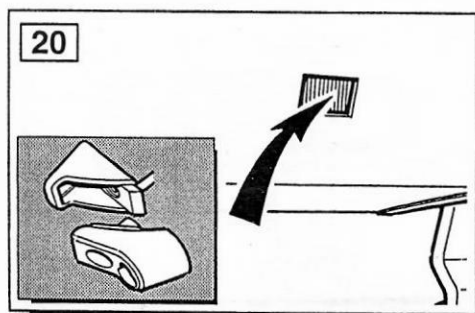
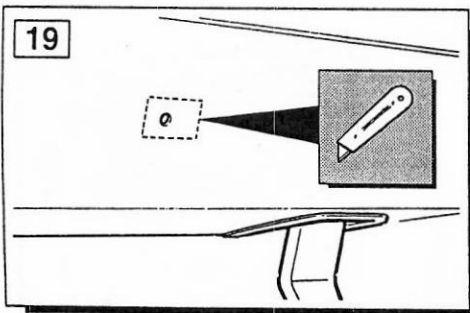
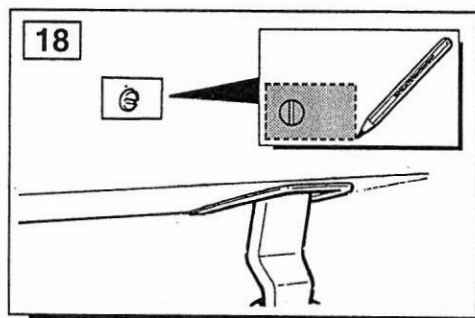
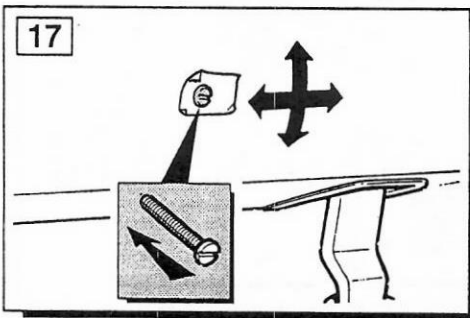
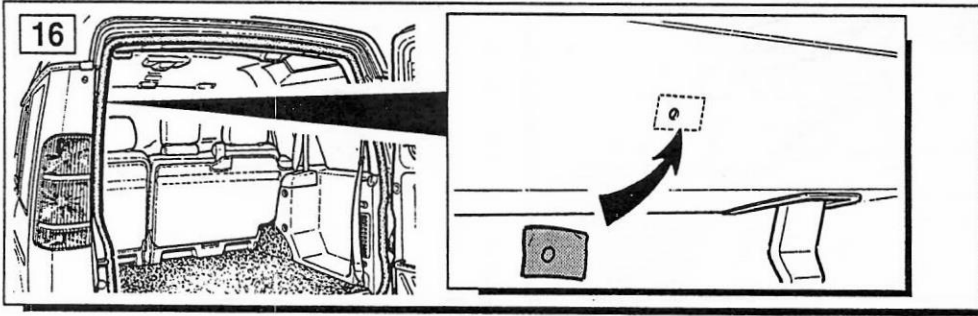
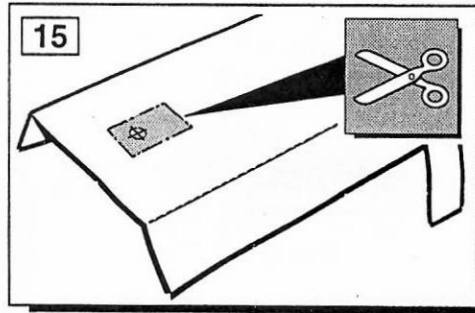
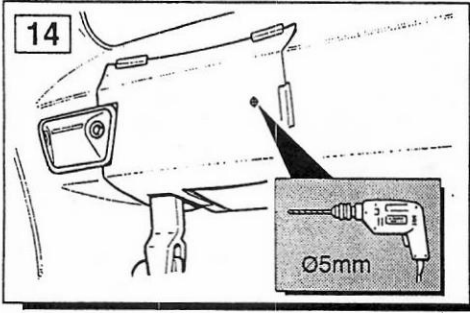

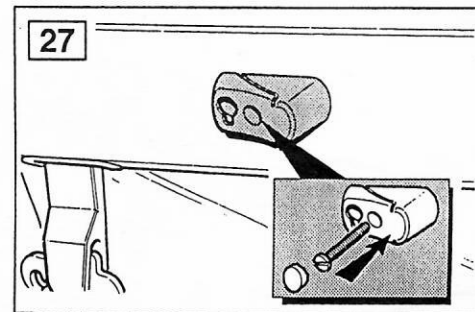
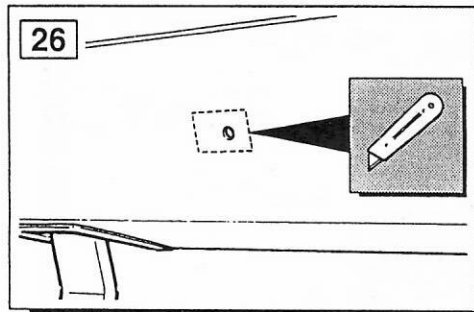
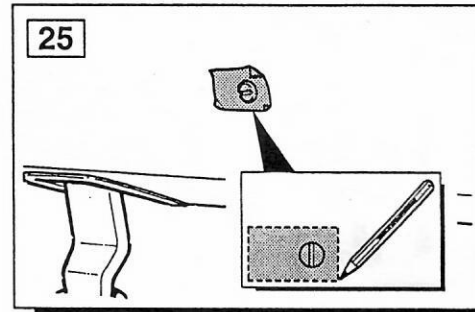
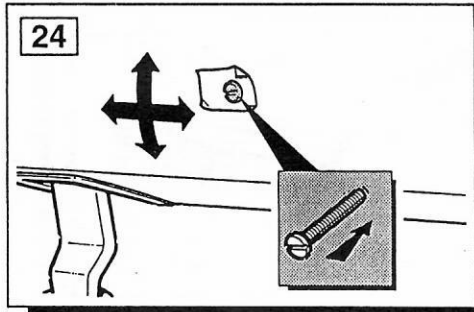
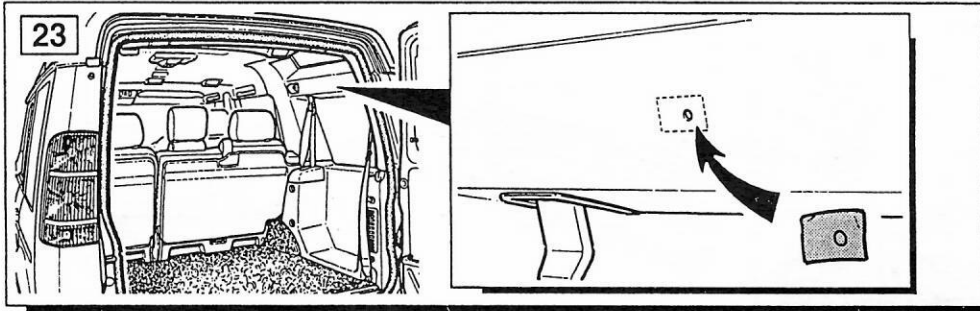
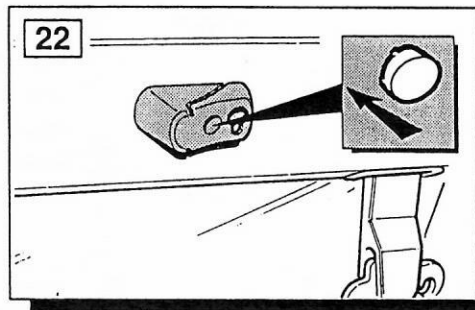
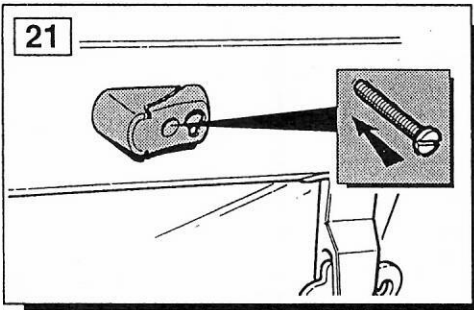

- 28**
- (GB) All vehicles
 - (D) Alle Fahrzeuge
 - (F) Tous les véhicules
 - (I) Tutti i veicoli
 - (E) Todos los vehículos
 - (P) Todos os Veículos
 - (NL) Alle voertuigen
 - (GR) Για Όλα τα Οχήματα
 - (B) 全車両

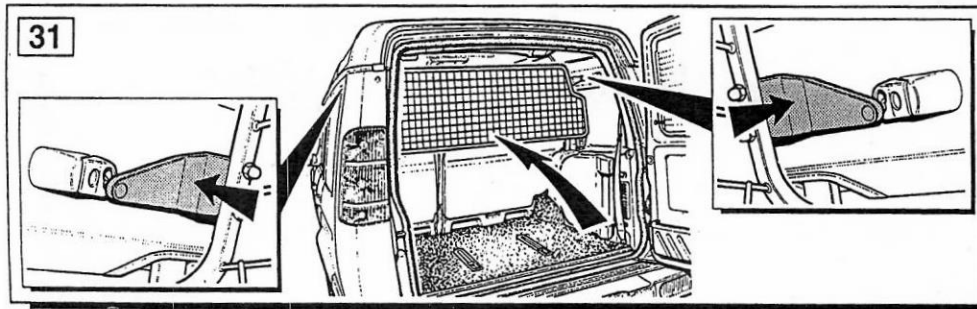
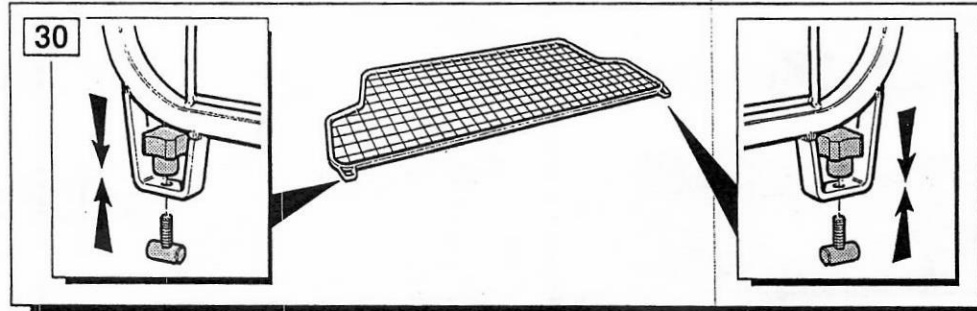
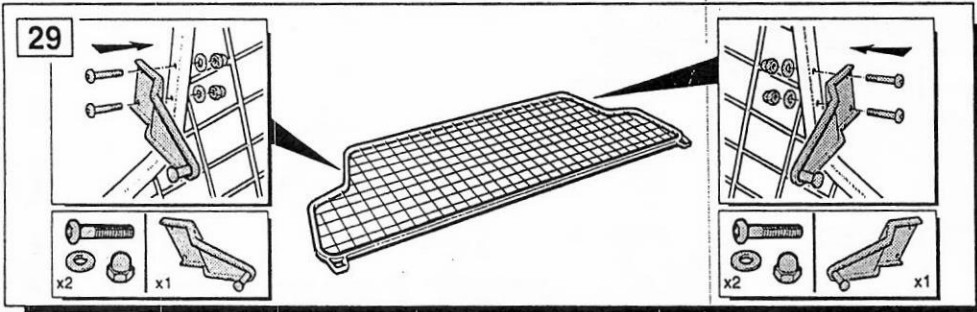

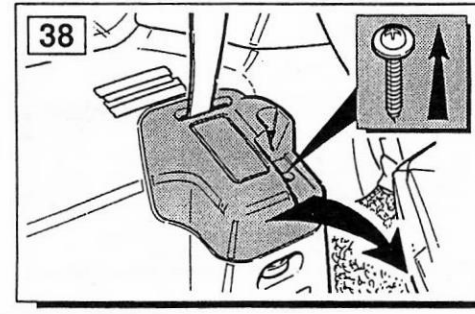
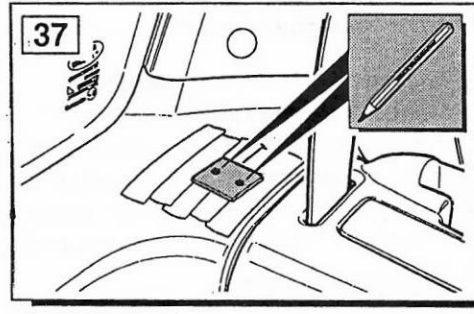
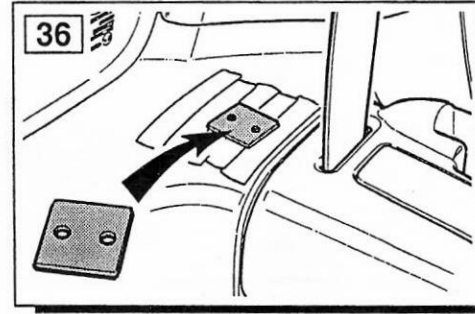
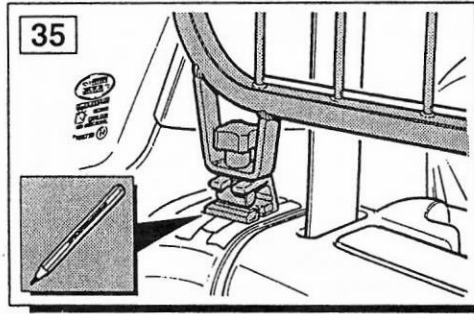
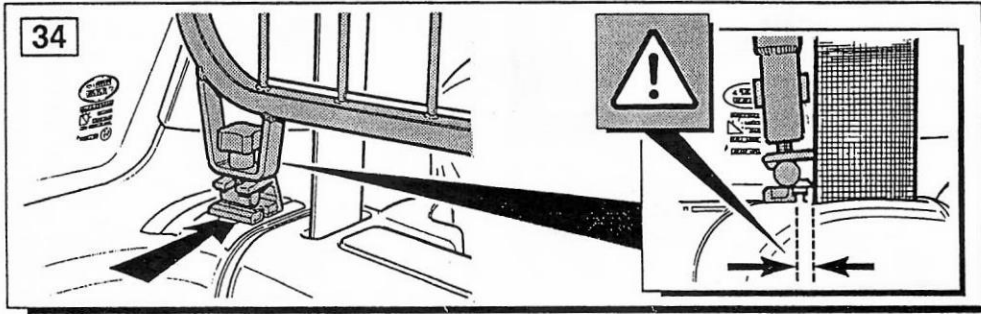
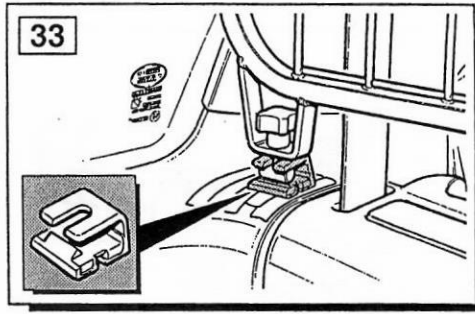
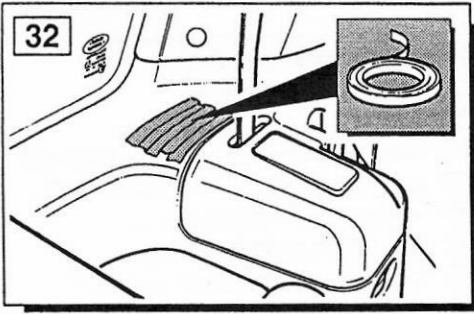

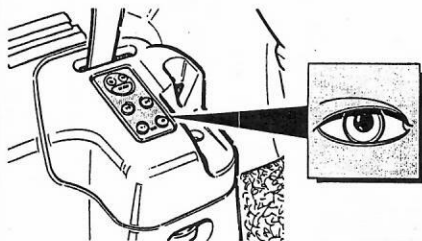

- (GB) Air Conditioning Only
- (D) Nur für Klimaanlage
- (F) Climatisation UNIQUEMENT
- (I) Condizionamento aria SOLAMENTE
- (E) Aire acondicionado SOLAMENTE
- (P) APENAS Ar Condicionado
- (NL) ALLEEN air-conditioning
- (GR) ΜΟΝΟ για τον Κλιματισμό
- (B) エアコンのみ

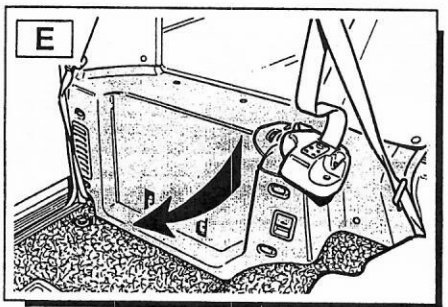
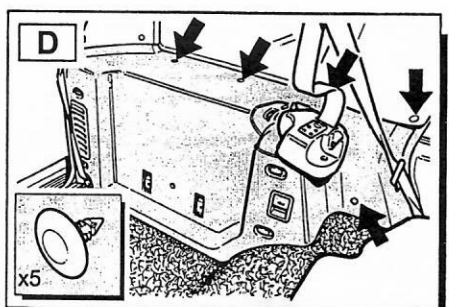
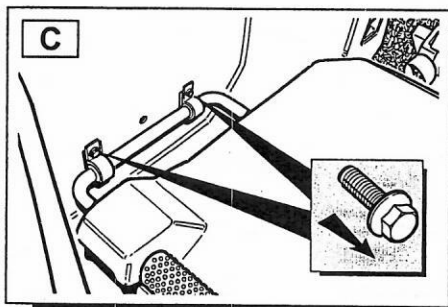
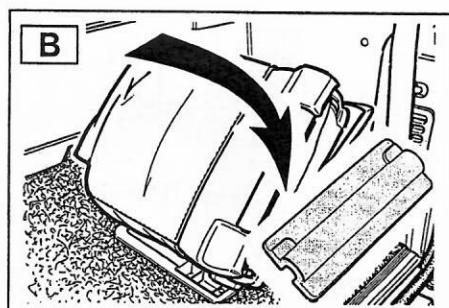
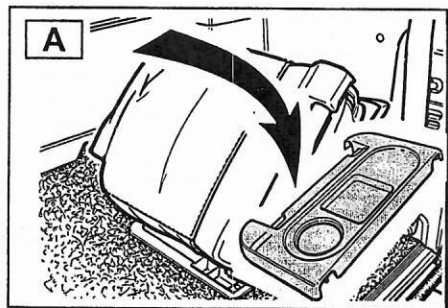

- (GB) Repeat procedure for opposite side.
- (D) Wiederholen Sie den Vorgang für die andere Seite.
- (F) Répéter la procédure sur le côté opposé.
- (I) Ripetere la procedura per il lato opposto.
- (E) Repetir el procedimiento para el lado opuesto.
- (P) Repita o procedimiento para o lado oposto.
- (NL) Volg dezelfde werkwijze voor de andere zijde.
- (GR) Επαναλάβετε τη διαδικασία για την αντίθετη πλευρά.
- (B) 反対側も同じ方法を繰り返す

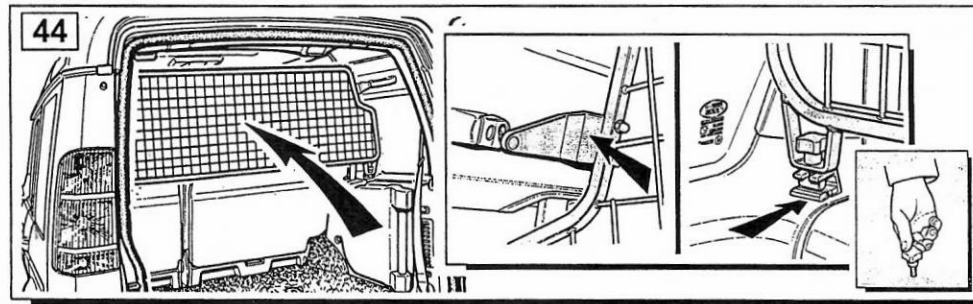
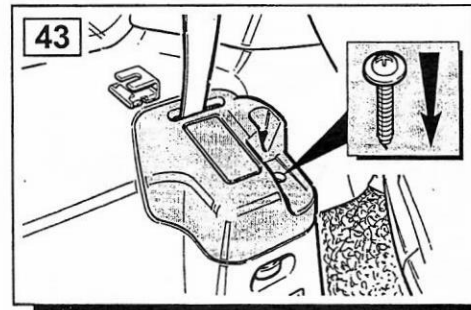
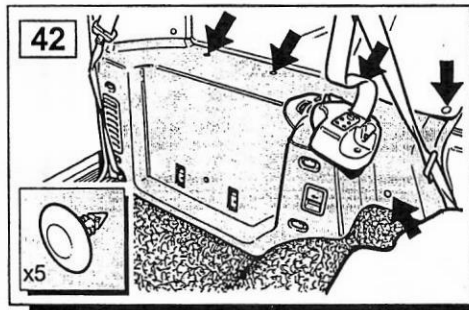
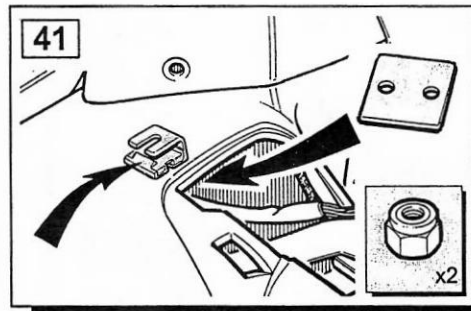
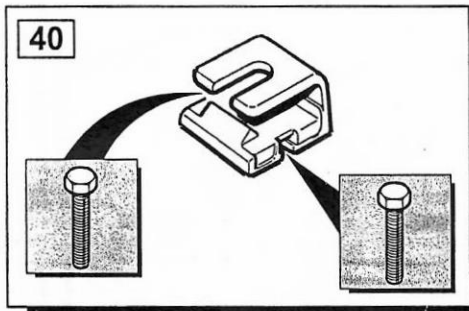
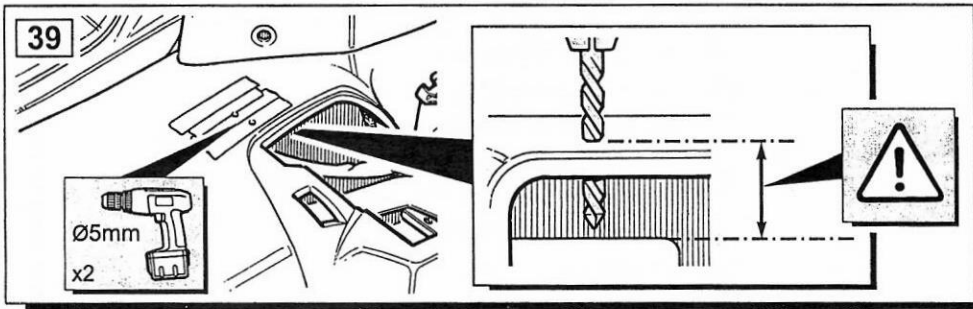

- (GB) Air Conditioning Only
- (D) Nur für Klimaanlage
- (F) Climatisation UNIQUEMENT
- (I) Condizionamento aria SOLAMENTE
- (E) Aire acondicionado SOLAMENTE
- (P) APENAS Ar Condicionado
- (NL) ALLEEN air-conditioning
- (GR) ΜΟΝΟ για τον Κλιματισμό
- (B) エアコンのみ

