

SEATS

Cover - cushion - front seat

78.30.01/81

Remove

1. Remove front seat.
2. Place seat on a suitable work bench.

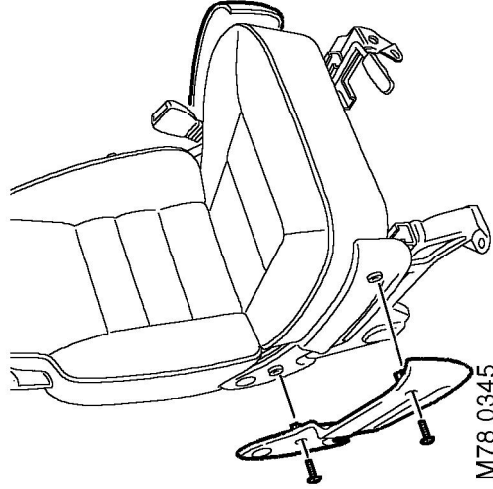

3. Remove 2 screws securing outer edge trim casing to seat frame.
4. Remove trim casing.
5. Release inner edge trim casing from seat frame.
6. Remove trim casing.

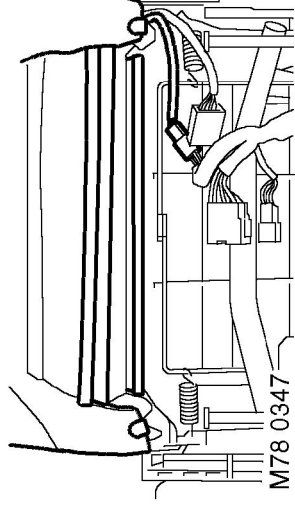

10. Release clip securing lower edge of squab cover to seat frame.
11. Remove 2 end clips securing rear edge of cushion cover to seat frame.
12. Release main central clip securing rear edge of cushion cover to seat frame.
13. **Models with seat heaters:** Disconnect seat heater multiplug.
14. Release bonded rear edge of cushion from seat frame.

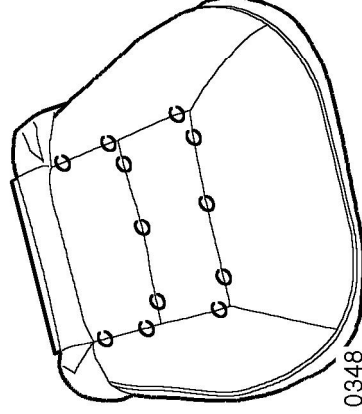

15. Remove seat cushion and cover assembly.
16. Release outer edges of cover from cushion to gain access to hog rings.
17. Remove 12 hog rings securing cover to cushion.
18. Remove cover.

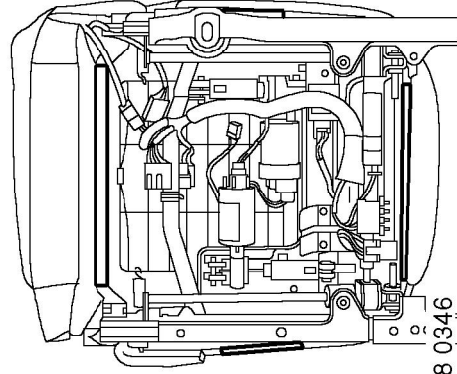

7. Position seat upside down on table.
8. Release clip securing front edge of cushion cover to seat frame.
9. Release clips securing side edges of cushion cover to seat frame.



SEATS

Heating element - cushion - front seat

→ 78.30.24

Remove

1. Remove front seat cushion cover.
 **SEATS, REPAIRS, Cover - cushion - front seat.**

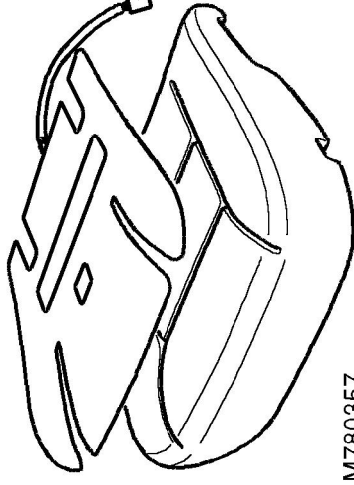

M780357

2. Carefully release heating element from cushion pad, ensuring adhesive does not tear cushion pad.

Refit

1. Ensure cushion pad is free of adhesive.
2. Remove adhesive cover from new heating element, position element and secure to cushion pad.
3. Fit front seat cushion cover.
 **SEATS, REPAIRS, Cover - cushion - front seat.**

Refit

1. Fit cover to cushion.
2. Fit and clamp hog rings securing cover to cushion.
3. Fit outer edges of cover over cushion.
4. Fit cushion and cover assembly to seat frame.
5. **Models with seat heaters:** Connect seat heater multiplug.
6. Secure rear edge of cushion cover with clip.
7. Fit end clips over rear edge of cushion cover.
8. Secure lower edge of squab cover to seat frame.
9. Secure edges of cushion cover with clips.
10. Secure front edge of cushion cover with clip.
11. Position seat correct way up on work bench.
12. Secure inner edge trim casing to seat frame.
13. Fit outer edge trim casing to seat frame and secure with screws.
14. Fit front seat.
 **SEATS, REPAIRS, Seat - front.**