

DISCO3CLUB

Land Rover
Discovery 3

Bodsy's Brake Bible

DISCO3CLUB

Ian Bodsworth

WWW.DISCO3CLUB.CO.UK in co-
operation with contributions from
DISCO3.CO.UK

August 2011

Version 1.6a

© Copyright Ian Bodsworth

Change Record

DATE	Revision	Update Notes	Made By
May 2010	1.2	Amended Torque Figures and bolt sizes, cleaned up photo areas. Updated text.	Ian Bodsworth
June 2010	1.2a	Re-worded EPB adjust procedure, updated EBP Allen key size. Added Change record	Ian Bodsworth
July 2010	1.3	Updated Tool List, inserted Tool/Job Matrix, added EPB change instructions, added jacking point pics, added Brake Pad Wear Sensor replacement & pics. +minor Word changes	Ian Bodsworth
August 2010	1.4	Updated Picture pointers, added Brake Bleed procedure (awaiting Pics). Added Jack Adapter Info & spreader Plate advice under Jack in hot weather.	Ian Bodsworth
Jan 2011	1.5	Removed Loctite Instruction on Torx50 screw when changing disks. Fitting 'Sticky' side of some OEM pads instructions updated. Added EPB Adjuster direction information. Section Link updated. Updated Remove Pads before Shim instructions. Added a few more pointers.	Ian Bodsworth
June 2011	1.6	Clarified EPB shoe instructions & corrected references to other sections. Added paypal donations information (requested by users of the guide.) Internationalised wheel location references by removing UK based reference to OS/NS, replaced with physical Front Left or Front Right descriptions.	Ian Bodsworth
August 2011	1.6a	Link updates	Ian Bodsworth

Table of Contents

1. Introduction.....	4
2. Tools that may be required.....	5
3. Jacking Points and Axle Stands	7
4. How to change the Brake Pads - Front	10
5. How to change the Brake Pads - Rear.....	14
6. How to change the Brake Pad Sensors - Front and Rear	18
7. How to change the Brake Disks - Front.....	20
8. How to change the Brake Disks - Rear	23
9. How to adjust the Electronic Park Brake.....	27
10. How to fit new EPB Shoes	29
11. How to Bed in new EPB shoes	32
12. How to replace the brake fluid and Bleed the braking system.....	33

1. Introduction

Welcome to **Bodsy's Brake Bible**. The aim of this 'Bible' is to provide a single area for all information relating to the servicing and maintenance of your Discovery 3 2,7 TDv6 braking system. It can be used as a basis for the V6 and V8 Petrol as well as the 3.0l TDv6, but I cannot guarantee it will be exactly right for those variants as I have not used this on those models. If you have used this guide on those models and have any updates we could use (inc pics) then please e-mail them to me d3bodsy@yahoo.co.uk and I will update this accordingly.

Please note that these are guidelines only and you should ensure that you are competent in the use of the tools required and take the necessary safety precautions. If you have any doubt of your competence, please contact your nearest Land Rover dealer or Land Rover independent garage who will be pleased to carry out this work for you.

Neither the author nor Disco3Club/Disco4Club can accept any responsibility for any accidents or injuries sustained whilst undertaking the work depicted in this bible.

All of the photos (unless otherwise indicated) are from my Discovery 3 MY07 TdV6 HSE.

Further technical information is available from Land Rover's subscription services TOPIx (ex-GTR) website, which can be found here:-

<http://topix.landrover.ilrext.com/topix/vehicle/lookupForm>

<http://www.landrovertechinfo.com/>

I acknowledge the assistance of members of the Disco3 forum and Land Rover® TOPIx/GTR for the initial guidance and advice before I commenced this guide which supersedes my previous collection of posts and other information.

2. Tools that may be required

Please find a list below of the tools that you will need to have in order to complete the tasks set out below.

A	B	C	D	E	F	G	H	I
	Front Pads	Front Disks	Rear Pads	Rear Disks	Park Brake Adjust	Park Brake Replace	Brake Pad Sensors	Brake Fluid Bleed/Change
Long Nosed Pliers	X	P	X	P		X	X	
Brake Cleaner	X	P	X	P		X	O	
Brake Fluid (Dot4)								X
10mm Brake Bleed Nipple Spanner								X
13mm Spanner	X	P	X	P		D		
15mm Spanner			X	P		D		
17mm Spanner	X	P		P		D		
Copper Grease	X	P	X	P		X		
Wheel Chocks (bricks or similar)	X	X	X	X	X	X	X	O
Rubber Mallet / soft faced hammer				X	X	X		
Ratchet for Sockets	O	O	O	O		O		
Trolley Jack	X	X	X	X	X	X	X	O
13mm Socket	X	P	X	P		D		
15mm Socket (bi-hex)				X		D		
21mm Socket (bi-hex)		X						
22mm Socket (Wheels)	X	X	X	X	X	X	X	
32mm Socket (deep)				X	X	X		
Torque Wrench for 6Nm, 35Nm	X	X	X	X	X	P/D		X
Torque Wrench for 40-90Nm, 115Nm, 140Nm	X	X	X	X	X	P/D	X	
Torque Wrench for 270Nm		X						
Axle Stands	X	X	X	X	X	X	X	X
T50 Torx Bit		X		X		D		
Breaker bar		X		X	X	X	X	
Calliper Retraction Tool or similar	X	P	X	P		D		
Latex or other protective gloves or barrier cream	X	X	X	X	X	X	X	X
Face mask and Goggles (against dust & rust)	X	X	X	X	X	X	X	X
Allen Key 4mm				X	X	D		
Strong wire / String		X		X		D		
Flat Blade Screwdriver				X	X	X		
Medium Thread Lock	X	X	X	X		D		
Pipe & Jar or Self Bleeding kit for Brake Bleeding								X
Torch				O	O	O		

Key : X – Required, O – Optional, P – Needed for Pads, D - Needed for Disks

I'll be looking to add OEM and Non OEM brake part numbers & rough costs to this schedule in the future. (Thanks Bruce)



All torque settings contained within this 'bible' are manufacturers recommended settings.

Optional additions to the tool kit are:-

- 1) Regular cups of tea/coffee
- 2) Box of plasters for grazed knuckles
- 3) A suitably sized swear box, depending on a combination of a) location b) weather c) temperature d) 'help' by young children/dog/neighbours ☺

3. Jacking Points and Axle Stands

The standard jack that comes with the Discovery 3 or 4, is widely regarded as 'not very good'. If you are going to do any work on your vehicle that requires raising the chassis, then we would recommend that you purchase or borrow a suitable trolley jack.

The Discovery 3 / 4 weighs in excess of 2.7 tonnes, so you need to ensure that you have a jack that is capable of supporting both the weight of the vehicle and the height that is required. NOTE: If jacking in hot weather on tarmac, place a suitable sized piece of wood under the jack to stop it digging into the softer tarmac.



Most hydraulic jacks are suited to standard sized cars. Your Discovery has a height range that requires a jack ideally capable of lifting 520mm.

One popular jack is the Clarke CTJ3000G, it is a heavy duty trolley jack available (at time of creation) at Machine Mart

<http://www.machinemart.co.uk/shop/product/details/ctj3000g-3-tonne-professional-garage-j>

Beware, there is also a CTJ3000QL which is a quick lift version of the above. There have been reports of this model twisting under load when used on a Discovery 3 or 4. There is a machined adapter that can be bought on the WWW that fits the CTJ3000G, which makes it easier to locate in the LR jacking holes. Search for "[Jack Adapter Clarke CTJ3000G Manufacture](#)"

There are specific jacking points underneath your car, DO NOT JACK ON YOUR AIR SUSPENSION COMPRESSOR COVER or on the long air compressor tank. You will damage it beyond repair.

Once you have jacked the car up, ensure that you use suitable axle stands to secure the car. I have these, rated at 6T (pair) and more than sufficient height available.



But others are available, such as these

<http://www.machinemart.co.uk/shop/product/details/cax-6tbc-6-ton-axle-stands>

Others are available, but the sturdier the better.



Ensure that your vehicle is securely supported on axle stands

before undertaking any work underneath it. Ensure that any wheels remaining in contact with the ground are securely chocked to avoid any unnecessary movement. If removing Wheels, loosen the wheel nuts before jacking off the ground.

WARNING: Always chock the wheels which are not to be raised.

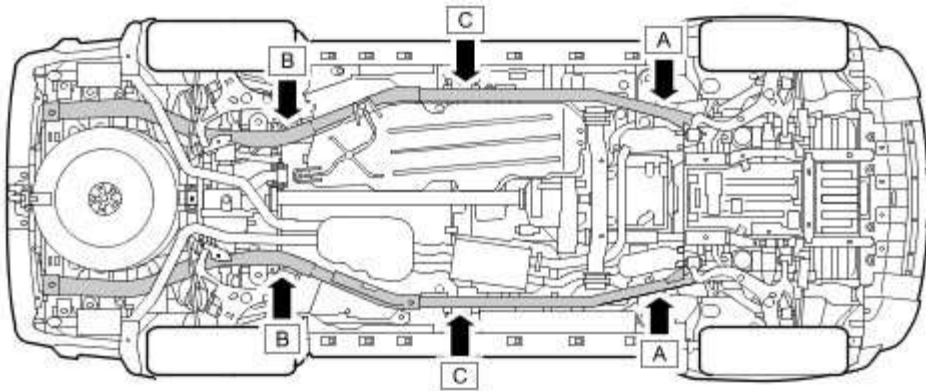

- **One front wheel** - position lifting pad of hydraulic jack beneath longitudinal member on the side to be raised at Point 'A'
- **One rear wheel** - position lifting pad of jack beneath longitudinal member on the side to be raised at Point 'B'
- **Front and rear wheels - ONE SIDE** - position lifting pad of jack beneath longitudinal member on the side to be raised at Point 'C'

NOTE:

Point 'C' is in line with number 3 body mounting.

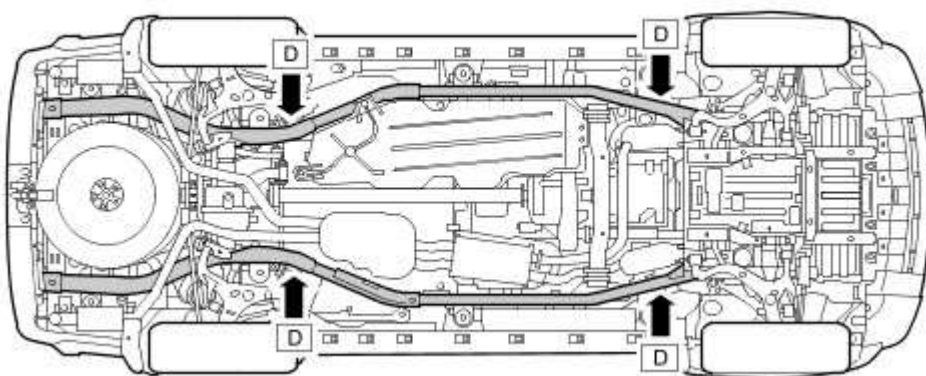

With vehicle at desired height, position axle stand(s) beneath longitudinal members and adjacent to the lifting pad of the jack at appropriate point(s) D.

 **CAUTION: Position suitable material between axle stands and longitudinal members to prevent damage to the longitudinal members.**

Carefully lower jack until vehicle rests on axle stands.

© Copyright Ian Bodsworth 2011. All descriptions and photo's contained within remain the property of the Author. Commercial images of products with copyrights acknowledged. E&OE. - Created by Bodsby – Disco3Club

Pictures below show the position of the LandRover supplied jack. I DO NOT RECOMMEND THAT YOU USE THIS JACK EXCEPT IN AN EMERGENCY.

In my opinion, this jack is not suitable for regular (or even irregular!) use on your Discovery3.

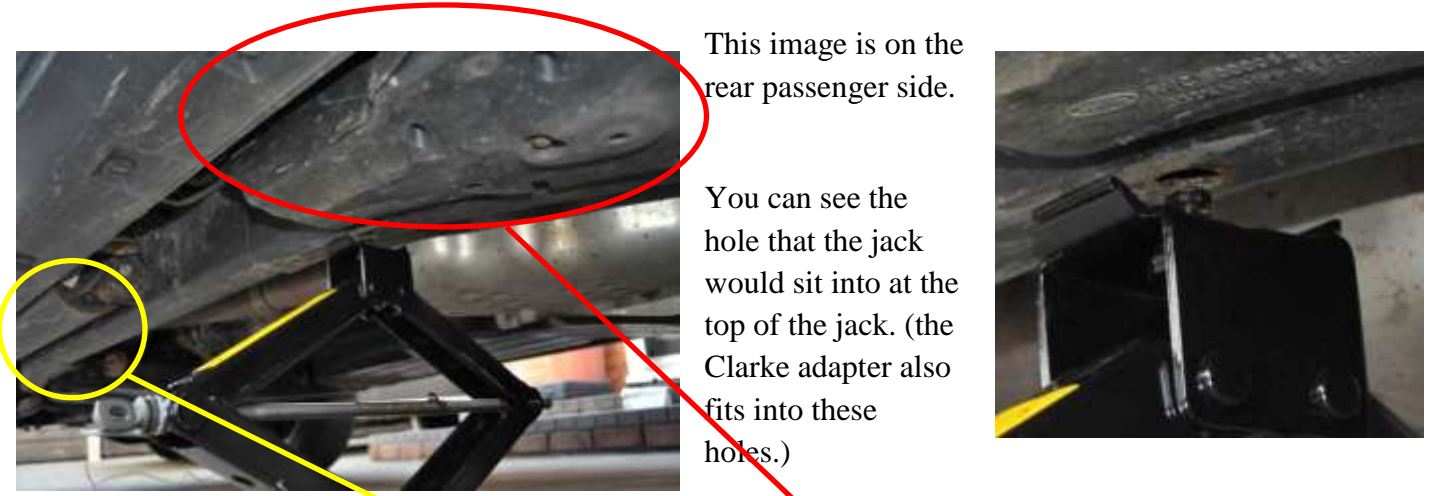

DO NOT jack on the **Air Compressor Receiver Tank** OR the **Air compressor cover**.

See use of Axle Stand for Safety.

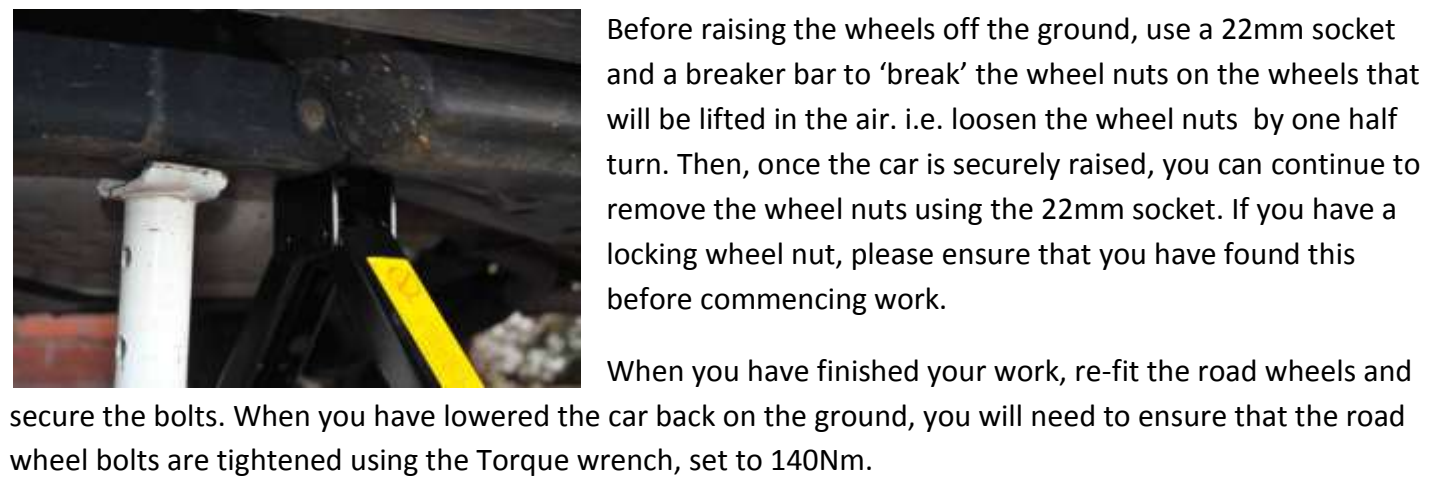

LR Jack pictures kindly supplied by Beau.

4. How to change the Brake Pads - Front

Ensure that your vehicle is securely supported on axle stands before undertaking any work underneath it. Ensure that any wheels remaining in contact with the ground are securely chocked to avoid any unnecessary movement.

Change Front Brake Pads (See page 5 for tool matrix)

Pliers	Copper Grease	Socket 13mm
Brake Cleaner	Optional Ratchet	Torque Wrench
Spanners, 13mm, 17mm		

The Discovery 3 has a Dual piston calliper brake system for the Front. It relies on hydraulic pressure from the braking system to push brake Pads onto the rotating Brake Disk. Over time, the Brake pads will wear down, eventually causing a loud scrapping noise as the brake pad backing plate grinds into the steel disk. If you have reached this point, then in all likelihood, you will need to replace the Brake disks as well as the pads.

The front LEFT side disk also has a brake wear sensor. If you have NOT broken through this sensor, then it can be safely re-used. Otherwise you need to ensure you have a replacement at the time of fitting.

Jack the car up (see Axle Stands & Jacking Points) Remove the front road wheels.



Once you have the road wheels removed, then you can remove the Brake pad wear sensor. (Front Passenger Side)

Use a pair of pliers to carefully extract the sensor. You may find that the brass contact in the sensor is also removed. Providing that you don't lose it or it doesn't ping off into a deep hidden crevice, then it should be able to be easily re-fitted.

You should pull the sensor directly backwards until it is removed.



Here you can see the **sensor** without the brass contact (which has remained on the brake pad).



Here you can see the **brass contact** which needs to be re-fitted or the whole sensor replaced.



You should also lift the Brake nipple protector and uncouple the sensor from it.

It should be able to be dangled down behind the hub.

Using a 13mm Spanner on the outside Calliper bolt, you also need a 17mm spanner to hold the inner nut. It was quite a tight fit for the 17mm spanner to fit in (width of spanner).

Undo the lower calliper bolt and discard (you should get new bolts with your replacement OEM kit, but CHECK FIRST) Only the outside bolt will come out, the inner bolt should move freely.

Then do the same for the top bolt, although after loosening the bolt, swing the brake calliper up to reveal the brake pads.



Remove the Brake Pads (these pads still had plenty of life, but I changed them as I was changing the disks)
Note Calliper had been fully removed in these next pics, this is not necessary for just replacing the front pads.



Remove the **Metal shims** (one bottom and one top)





This is what you should expect from an OE set of Front Brake Pads.

2 replacement Bolts (the Blue is thread loc)

2 replacement Shims (you can re-use old Shims, but best to have replacements)

2 OE Brake Pads

Fit the new Shims to the Calliper holder (note new disks had been fitted before this). The Shims just press on & click into place.



Before fitting the Brake Pads, ensure you use a liberal coating of Copper Grease to the top and bottom lugs of the brake pad to keep the brake pads easily moving. Applied by tube in this case.



Re-fit the brake pads with the friction surface facing inwards. Be sure that there is no grease on the front of the brake pad. If the pads have a sticky label, ensure that this is on the Non Piston side of the calliper.

With the brake Calliper, spray plenty of brake cleaner on the calliper and then use a Calliper Piston Retraction tool or other home made device to retract the brake callipers into the body. This should be done as squarely as possible. (NB. It may require you to remove some of the Brake Fluid from the Master Cylinder, but I didn't need to when I did all four wheels).

Re-Fit the Brake Calliper into position and re-fit the bottom calliper bolt that came with the Brake pad kit using the 13mm and 17mm spanner. Then remove the top calliper bolt (discard it) and replace with the other bolt from the Brake pad kit.

Tighten the bolts to 35Nm using the torque wrench and 13mm socket.





With the Brakes all attached, ensure that the Brake Pad Wear Sensor has the metal clip on it before pushing gently back into position. Ensure that the **brake Bleed Nipple** is covered with the rubber cover again.

Repeat for the opposite side.

Note Brake Wear Sensor is only

on one side of each axle.



5. How to change the Brake Pads - Rear

Ensure that your vehicle is securely supported on Axle stands before undertaking any work underneath it. Ensure that any wheels remaining in contact with the ground are securely chocked to avoid any unnecessary movement.

Change Rear Brake Pads (See page 5 for tool matrix)

Pliers	Copper Grease	Socket 13mm
Brake Cleaner	Optional Ratchet	Torque Wrench
Spanners, 13mm, 15mm		

The Discovery 3 has a single piston calliper brake system for the rear. It relies on hydraulic pressure from the braking system to push brake Pads onto the rotating Brake Disk. Over time, the Brake pads will wear down, eventually causing a loud scrapping noise as the brake pad backing plate grinds into the steel disk. If you have reached this point, then in all likelihood, you will need to replace the Brake disks as well as the pads.

The rear right side disk also has a brake wear sensor. If you have NOT broken through this sensor, then it can be safely re-used. Otherwise you need to ensure you have a replacement at the time of fitting.



Jack the car up (see Axle Stands & Jacking Points) Remove the rear road wheels.

Once you have the road wheels removed, then you can remove the Brake pad wear sensor. (Rear Right Side)

Use a pair of pliers to carefully extract the sensor. You may find that the brass contact in the sensor is also removed. Providing that you don't lose it or it doesn't ping off into a deep hidden crevice, then it should be able to be easily re-fitted.

You should pull the sensor directly backwards until it is removed.



The sensor without the brass contact (which has remained on the brake pad) can be seen in the Front Brake Pads section as well as the brass contact which needs to be re-fitted or the whole sensor replaced.



Using a 13mm Spanner on the outside Calliper bolt, you also need a 15mm spanner to hold the inner nut. It was quite a tight fit for the 15mm spanner to fit in (width of spanner).

Undo the lower calliper bolt and discard (you should get new bolts with your replacement kit, but CHECK FIRST) Only the outside bolt will come out, the inner bolt should move freely.

Then do the same for the top bolt, although after loosening the bolt, swing the brake calliper up to reveal the brake pads.



Remove the Brake Pads (these pads still had plenty of life, but I changed them as I was changing the disks) Note Calliper had been fully removed in these next pics, this is not necessary for just replacing the front pads.

Remove the **Metal shims** (one bottom and one top)



This is what you should expect from an OE set of Rear Brake Pads (pic shows front pads).

2 replacement Bolts (the Blue is thread loc)

2 replacement Shims (you can re-use old Shims, but best to have replacements)

2 OE Brake Pads

Fit the new Shims to the Calliper holder (note new disks had been fitted before this). The Shims just press on & click into place.



© Copyright Ian Bodsworth 2011. All descriptions and photo's contained within remain the property of Ian Bodsworth. Commercial images of products with copyrights acknowledged. E&OE. - Created by Bodsy - DiscosClub



Before fitting the Brake Pads, ensure you use a liberal coating of Copper Grease to the top and bottom lugs of the brake pad to keep the brake pads easily moving. Applied by tube in this case.

Re-fit the brake pads with the friction surface facing inwards. Be sure that there is no grease on the front of the brake pad.

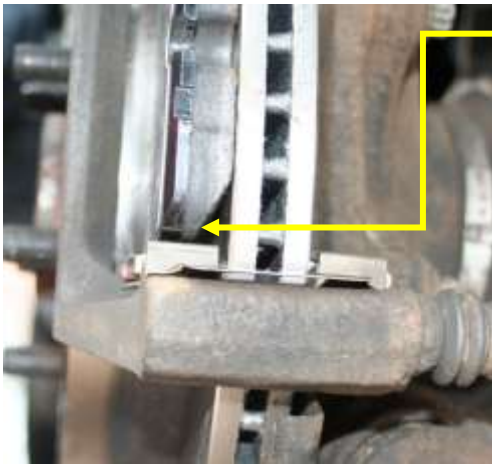

Note the **chamfered edge** on the pads showing at the bottom to assist with bedding in. N.B. There are some new style pads also available that do NOT have the Chamfer, but have a sticky label. Remove the sticky label cover. The sticky label side should be on the NON Piston side of the calliper.

With the brake Calliper, spray plenty of brake cleaner on the calliper and then use a Calliper Piston Retraction tool or other home made device to retract the brake callipers into the body. This should be done as squarely as possible. (NB. It may require you to remove some of the Brake Fluid from the Master Cylinder, but I didn't need to when I did all four wheels).

Re-Fit the Brake Calliper into position and re-fit the bottom calliper bolt that came with the Brake pad kit using the 13mm and 15mm spanner. Then remove the top calliper bolt (discard it) and replace with the other bolt from the Brake pad kit.

Tighten the bolts to 35Nm using the torque wrench and 13mm socket.

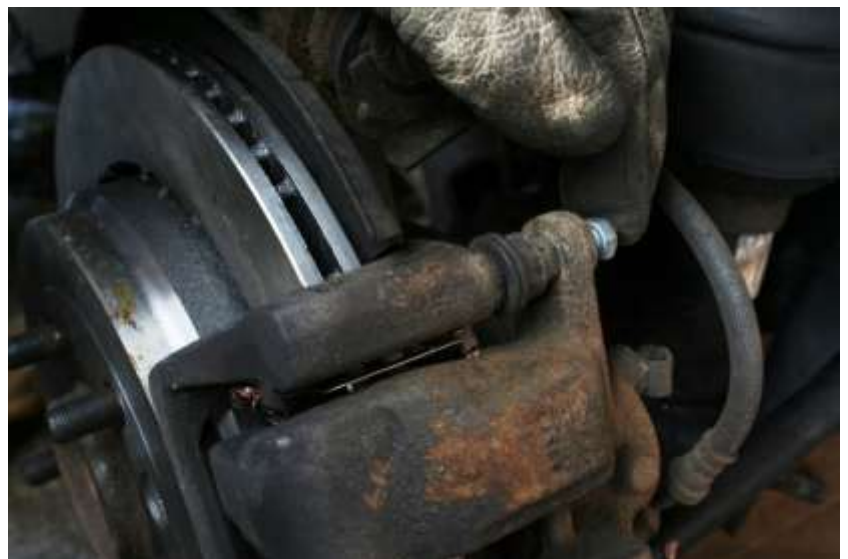

With the Brakes all attached, ensure that the Brake Pad Wear Sensor (Right side rear) has the metal clip on it before pushing gently back into position.

Rear left side



Rear right Side



6. How to change the Brake Pad Sensors - Front and Rear

There are 2 sensors, one on front left side and one rear right side (UK Drivers side).

Front Sensor (See page 5 for tool matrix)

Follow the first section of the 4. Changing Brake Pads Front.

Up to the point where you have removed the Brake Pad Wear sensor at the Pad end. Check that it has worn through the plastic and that you definitely need to replace it.



If you look at the new one in the bag it'll give a good hint as to what you're looking for.

As you remove the old sensor cable, replace it with the new one. This will help to ensure that you follow the correct route. Ensure you clip the cable into the same places as the old one.

Once you get up near the top of the wheel arch you'll see the cable goes behind the plastic interior trim of the arch.

It's much easier if you undo or pull out the three nearest

plastic clips(removed) that hold the plastic arch in place.

The arch is very strong, so don't be afraid to bend it over & out of your way as much as possible.



A **piece of wood** was used in this case to keep the plastic out of the way.



Now LOOK CAREFULLY at the connector on the new one, you'll see at the far end the **clip mechanism** that you need to release to get the old one off, DONT just pull, you'll break things..

Once it's off then plug in the new one.

Well done, now you can put it all back together, if you didn't snap any of the screw thingy's then put them all back

Wheel back on and we're ready for the rear sensor.

Rear Sensor

Follow the first section of the 5. Changing Brake Pads Rear.

Up to the point where you have removed the Brake Pad Wear sensor at the Pad end. Check that it has worn through the plastic end and that you definitely need to replace it.

If you look at the new one in the bag it'll give a good hint as to what you're looking for. As you remove the old sensor cable, replace it with the new one. This will help to ensure that you follow the correct route. Ensure you clip the cable into the same places as the old one.



The difference with the rear sensor, is that the cable DOESNT go up inside the car, it follows round the back of the suspension drum and clips in just behind, you can reach it from the **left side of the drum.**

By the end you should have maybe a couple of bloody knuckles as well as a nice scratch up your right arm...

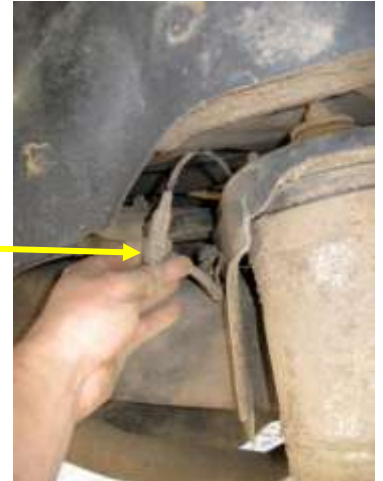

Thanks to Ade & Richard for supplying the sensor pics & Ade for the initial write up.

N.B. If you DON'T want to have brake pad wear sensors enabled, then simply cut the old sensor at an appropriate point between the end of the sensor and the connector and join the two resulting wires together. Seal with waterproof tape or sealant and tuck up out of the way. It will think that the circuit is completed and therefore that the brakes are OK.

If you take this option, you must ensure that you regularly check your brake pads and disks and take any necessary remedial action as the car will no longer warn you of imminent wear.

7. How to change the Brake Disks - Front

Follow the instructions in section 4 to remove the brake pads.

Tools Required to Change Front Brake Disks (See page 5 for tool matrix)

Pliers	Copper Grease	Torque Wrench
Brake Cleaner	Optional Ratchet	Strong Wire or String
Spanners, 13mm, 17mm	21mm Bi-Hex (12pt) socket	T50 Torx Bit
Rubber Mallet	Socket 13mm	Breaker Bar



Discard the brake pads and ensure you fit new brake pads when you fit new brake disks. See section 4. **How to change the Brake Pads - Front**

Fully remove the calliper and ensure that it is supported so that you do not put too much strain on the brake pipe components. I used a piece of strong wire and tied it to form a loop. **As per picture.**

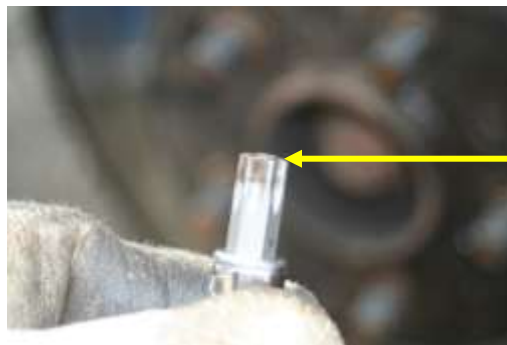

Then find the **Torx Screw** (Size T50) on the face of the disk.

Clear out any brake dust or mud from the screw head. Brake Disk cleaner is ideal.

Insert the Torx and gently tap it in with a hammer to ensure it is fully home.



Then undo the Screw carefully. I generally tend to very slightly tighten the screw to break any seal that has formed and then undo the screw. The hub may still move,

so I start with a few sharp taps on the end of the ratchet to get the screw moving.

You then need to remove the calliper bracket.



There are **two 21mm Bi-Hex bolts**. These will be very stiff and require a breaker bar to undo.

For the top bolt, you could also remove the **cable bracket** if you need to gain better access, just be careful with the **wheel speed sensor cable**.



Bottom Bolt should be clear.



With the Bracket removed, **KEEP THE BOLTS**, these do not get replaced in a disk kit.



The T50 screw can be removed, along with the brake disk. The disk **MAY** need to be gently tapped off with a rubber mallet or similar.



You can see the new and old Disk side by side. The old disk has a very prominent 'lip' on the inside of the disks. This can sometimes be removed as long as the width of the disk is still within tolerance (27mm minimum for Front).



Put the new disk on, remembering to align the Torx Screw hole onto the hub. When re-fitting the screw, **Do not** put thread lock on it as it will be secure enough. (pic shows threadlock ON)



Using the Torque Wrench, set it for 35Nm and tighten the Torx screw.

Tap the Disk on fully and check the torque setting again.



You then need to re-fit the Calliper carrier bracket. Again, I applied some medium thread loc before re-fitting.

Set the Torque Wrench to 275Nm. Note that this is very high and most 'normal' torque wrenches will only go up to 200Nm.

When both bolts have been re-fitted and the torque set, continue to refit the brake pads and calliper. See section 4. **How to change the Brake Pads - Front**



8. How to change the Brake Disks - Rear

Follow the instructions in section 5 to remove the brake pads.

Tools Required to Change Rear Brake Disks (See page 5 for tool matrix)

Pliers	Copper Grease	Strong Wire or String
Brake Cleaner	Optional Ratchet	T50 Torx Bit
Spanners, 13mm, 15mm	15mm Bi-Hex (12pt) socket	Breaker Bar
Rubber Mallet	Socket 13mm	32mm Socket (1-1/4")
Flat Blade Screwdriver	Torque Wrench	Torch

Before removing the rear Brake disks, please carry out this sequence to put the Electronic Park Brake into Service Mode. Ensure brake pads and calliper is fitted to all wheels.

In the car with ignition in Position II, press the brake pedal three times and hold the pedal down. Push down on the EPB switch for 3-5 seconds.

Go to the main fuse box in the engine bay and remove FL8 fuse 30A (pink Fuse) this will ensure that the EPB is not accidentally re-engaged.

Following the first section on how to change the brake pads, lift and remove the road wheels.

Discard the brake pads and ensure you fit new brake pads when you fit new brake disks. **See How to change the Brake Pads - Rear**

Fully remove the calliper and ensure that it is supported so that you do not put too much

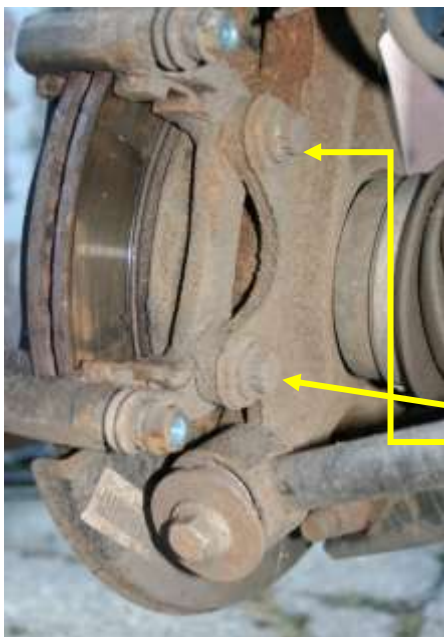

strain on the brake pipe components. I used a piece of strong wire and tied it to form a loop. **As per picture.**



You then need to remove the calliper bracket.

There are two **15mm Bi-Hex bolts**. These will be very stiff and require a breaker bar to undo.



With the Bracket removed, KEEP THE BOLTS, these do not get replaced in a disk kit.

Using a flat blade screwdriver, remove the plastic plug to reveal a hole.



Then find the Torx Screw (Size T50) on the face of the disk.



Clear out any brake dust or mud from the screw head. Brake Dust cleaner is ideal.

Insert the Torx and gently tap it in with a hammer to ensure it is fully home.

Then undo the Screw carefully. I generally tend to very slightly tighten the screw to break any seal that has formed and then undo the screw. The hub may still move, so I start with a few sharp taps on the end of the ratchet to get the screw moving.

Turn the disk until the hole (that you removed the plastic plug from) is at the bottom (Right side is upside down from Left side). (you could use a torch to help) Behind the disk, it looks like this:-



Using the flat blade screwdriver through the hole, release the ratchet one click at a time until it is fully undone. (move in the direction AWAY from the EPB spring to release and Towards to tighten up)

Then the T50 screw can be removed, along with the brake disk. The disk MAY need to be gently tapped off with a rubber mallet or similar.



You can see the new and old Disk side by side. The old disk has a very prominent 'lip' on the inside of the disks. This can sometimes be removed as long as the width of the disk is still within tolerance (Rear disk is 17mm minimum)



You will more than likely need to give the disk a quick clean with brake cleaner to remove any oils that may be on the braking faces of the disk.

Put the new disk on, remembering to align the Torx Screw hole onto the hub. When re-fitting the screw, **do not** put thread lock on as it will be secure enough.



Using the Torque Wrench, set it for 35Nm and tighten the Torx screw. Tap the Disk on fully and check the torque setting again.



You then need to re-fit the Calliper carrier bracket. Again, I applied some medium thread loc before re-fitting.



Set the Torque Wrench to 115Nm.

When both bolts have been re-fitted and the torque set, continue to refit the brake pads and calliper. See **How to change the Brake Pads - Rear**

Once completed on the right side, do the same for the left side. When both sides are completed, ensure that you re-fit the FL8 fuse, otherwise your EPB will not function.

Ensure you carry out **How to adjust the Electronic Park Brake**

9. How to adjust the Electronic Park Brake

The Electronic Park Brake is operated by a pair of brake shoes on the inside of the rear brake disks.

The manufacturer recommends that you strip, clean and adjust the EPB after 50 miles of off road conditions or arduous use.

If you have a loud screeching noise when the EPB is applied, then often an adjustment of the Electronic Park Brake will fix this.

This procedure **MUST** be carried out when you change your brake disks and/or brake shoes. If the pads are worn below the limit, you should replace the pads as well as go through the Electronic Parking Brake Shoe Bedding In Procedure.

Tools Required to adjust the Electronic Park Brake(See page 5 for tool matrix)

Flat Blade Screwdriver

Torque Wrench

32mm Socket (1-1/4")

Allen Key/Hex (4mm)

Ensure that your rear wheels are off the ground and the car is on axle stands or a car lift. Remove the rear road wheels.

For a Manual, you don't want the EPB to apply automatically, you should Push the EPB button **DOWN** whilst switching off the ignition and removing the key.

For an Auto, just don't apply it.

The above should be fine if you are leaving the disks on and just adjusting the EPB.

If you're removing the disks for a full clean, then I'd recommend **putting it into service mode** and removing the 30a fuse as per section **8 How to Change Your Brake Disks - Rear** of the bible.



There are two adjustment parts to the EPB.

Using a flat blade screwdriver, remove the **plastic lug** to reveal a hole. Turn the disk using the 32mm Hub Socket until the hole (that you removed the plastic plug from) is aligned with the first adjustment point.

Behind the disk, it looks like this (Left side. Right side will be upside down to this) :-

There are two adjustment points. One is the **4mm Hex bolt(Allen Key)** (circled Yellow). The other is the **ratchet** (hidden at the bottom, circled in Red)

Rotate the disk again until the hole is in line with the ratchet adjuster (Red) (The direction of rotation must always be forward). Using the flat blade screwdriver through the hole, tighten the ratchet until it is tight. (move in the direction AWAY from the EPB spring to release and Towards to tighten up)

Then take your torque wrench and 32mm socket and set it for between 40 and 90Nm.

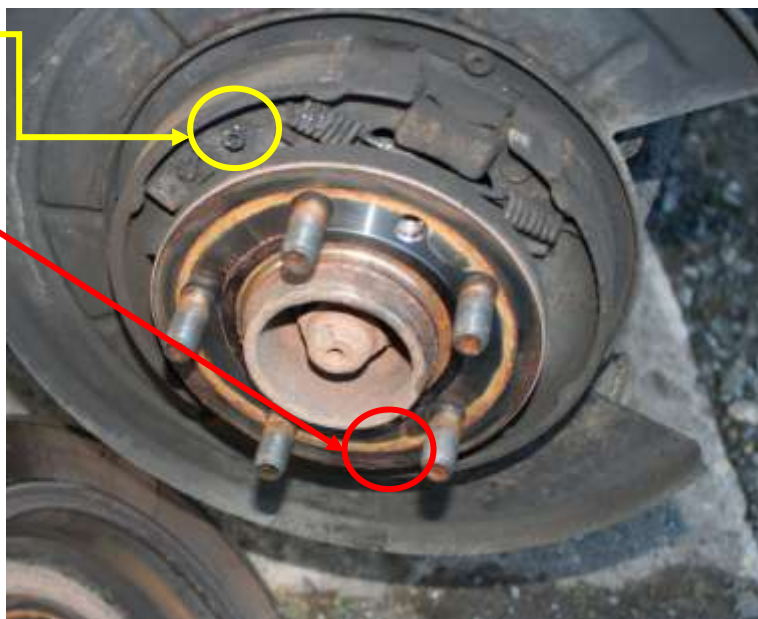

Place it on the hub nut and if the disk turns, you need to add one click at a time to the ratchet with the screwdriver until the required torque is reached (I set my torque to 60Nm for this exercise). When the Torque is reached, then you need to release the ratchet by exactly 8 clicks back.



Finally, rotate the disk until the hole is in line with the Hex socket (Yellow) and undo this half a turn. Gently tap the disk with a rubber faced mallet around the shoe area. This will release the tension and it should naturally move if it needs to. Tighten the Hex socket back up to 6Nm.

When that is completed (on both rear wheels), replace the plastic lug and re-fit the road wheels.

If they are new disks or pads, please complete **Section 11 How to Bed In New EPB Shoes**.

10. How to fit new EPB Shoes

(See page 5 for Tool Matrix) Remove the brake Disks (see 8. How to Change the Brake Disks - Rear).

You should replace your EPB Shoes when the lining material is down to 2mm.

Images shown here are for the Right side rear.

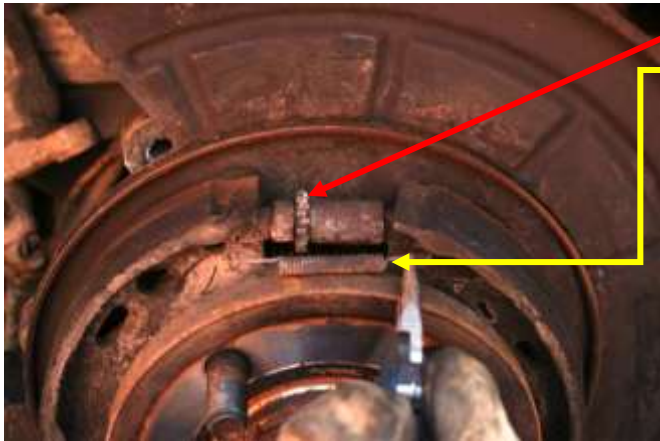

With the Brake Disks removed, release the **knurled adjuster** and **return spring**.

Ensure your replacement shoes come with new springs and hold down springs before discarding the old springs (otherwise give the old ones a good clean). KEEP the knurled adjuster, clean and lubricate it with copper grease.

The shoes consist of a Primary and a Secondary shoe. The Primary shoe is the right hand shoe (Pic is of whole Rear Right side).

Remove the **hold down spring** on the Primary shoe.

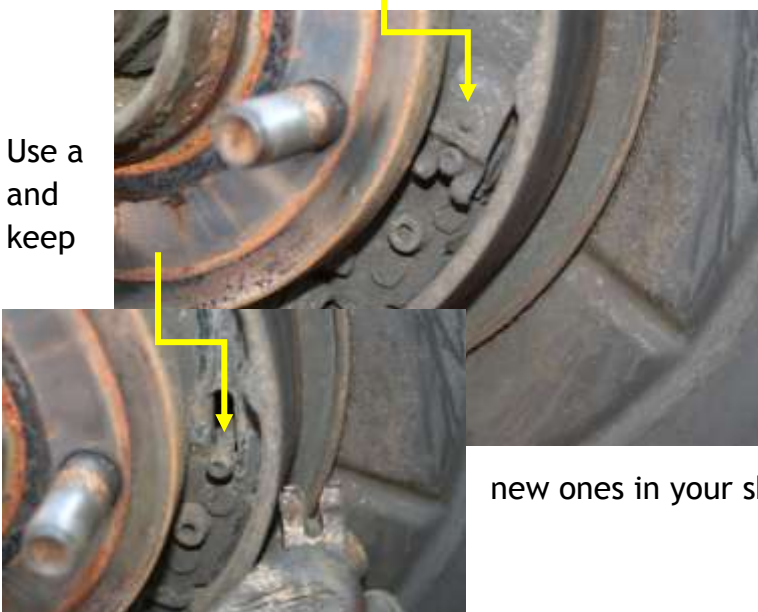

Use a
and
keep

screwdriver to press the hold down spring
your other hand to the back of the hub to
the **retaining pin** in place.

Remove the spring and pin (you should have
new ones in your shoe kit)

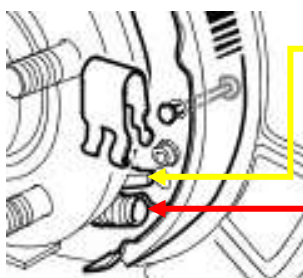

Pivot the Primary shoe so that the **spreader plate** (hidden behind the hub) and **return spring** are released. This can be tricky, but it's a case of getting it in the right position.

Remove the Primary shoe.

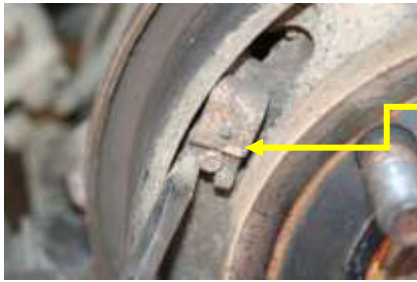

Remove the Hold Down **spring and pin** on the secondary shoe.



Unhook parking brake **retaining spring**. (see top insert)

Release the **Parking brake Cable** and remove the secondary shoe. (see bottom insert)

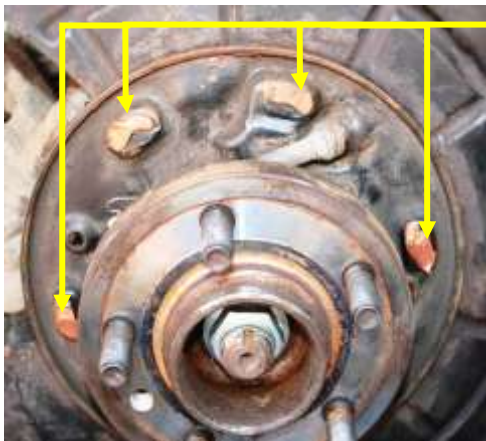

Clean all the Brake contact rubbing points and apply **copper grease** to all the raised rubbing points (6 in total, 2 not in view).

Install the new secondary brake shoe. First install the **Parking Brake cable** and attach the **retaining spring**. Ensure that the spring is not twisted as this may affect it's operation.

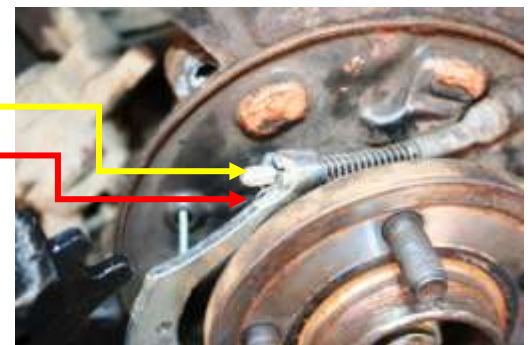

Insert the new **Hold down spring and pin**. (you might need three hands for this one!) One suggestion is to use a small cable tie to compress the spring before use & then once installed, simply cut and then remove the small cable tie

Insert the new **Return Spring**. Please note the direction of the 'hook' If you install it upside down, you will not be able to connect it to the Primary shoe.

Install the **Spreader Plate** and Spring. See pic for installed components off the car (as an example).

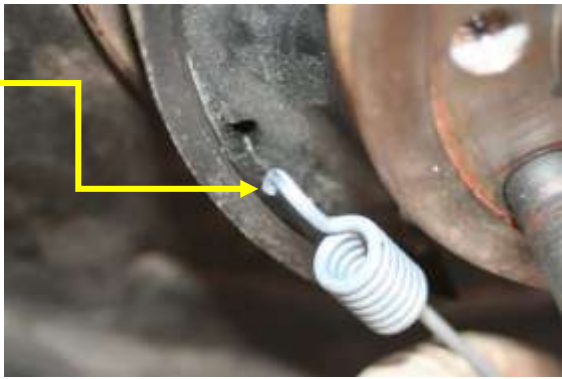

Use a small **tie wrap** on the spreader plate spring to make it easier to install (Make sure you remember to cut it off once the plate is installed).

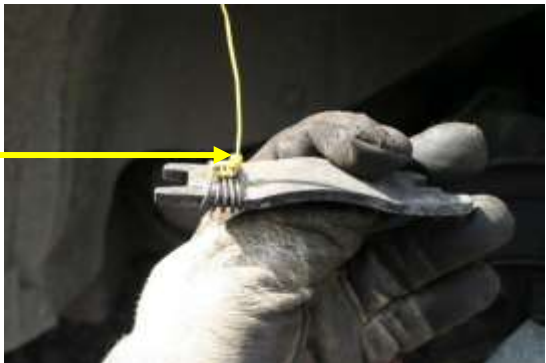

Insert the **knurled adjuster** (I put some copper grease on to ensure it doesn't seize)

Also insert and attach the **return spring**



Insert the replacement **hold down spring and pin**.

Once you have completed that, you need to re-fit the Brake Disk. You may find that the disk does not fit on easily, you may need to gently tap the shoes to move them up or down on the hub so that the disk fits over them. I found that rotating the disk helped it to fit back on.

With the Disk on, you need to complete the brake calliper and pads installation and then go on to section 9. How To adjust the Electronic Parking Brake.

11. How to Bed in new EPB shoes

You need to bed in the EPB shoes either when you have changed the EPB shoes or you have changed the rear discs.

With the Engine running, press the brake pedal fully on and off 3 times. On the third press, hold the brake pedal down.

With the brake pedal still in the down position, pull the EPB switch upwards 4 times and then downwards 3 times. This must be completed within 10 seconds.

Your dash display will then show 'Park Brake Bedding Cycle Active' or something similar. If it hasn't, then release the brake pedal and try again.

You need to ensure that you are on a clear piece of road or land as this procedure needs to be completed 10 times.

Drive at least 19mph and maximum of 29mph and then apply the EPB switch until you stop. You then need to wait for 60 seconds or drive for 500metres (to allow the brakes to cool down) before repeating the process. If you stop the engine or you drive over 30 MPH, the bedding in process will be cancelled. At the end of the 10th time, the bedding in mode may automatically finish, or you should just drive more than 30mph or cycle the ignition.

12. How to replace the brake fluid and Bleed the braking system

Tools Required to Change Rear Brake Disks (See page 5 for tool matrix)

Brake Bleed Nipple Spanner Plastic Pipe Brake Bleed Pot

Brake Fluid (LR Spec is SHELL DONAX YB DOT4 ESL FLUID. Otherwise, use a low viscosity DOT 4 brake fluid meeting ISO 4925 Class 6 and Land Rover LRES22BF03 requirements) ISO 4925 is the key if you can't find the LR Brake Fluid.

Pictures to be updated.

There are two procedures available.

1 is the manual procedure that should only be used when you have not introduced air UPSTREAM of the Hydraulic Control Unit. If you have removed brake calliper or pipe connecting to the calliper, you are likely to be in this category.

2 is the System procedure using T4 or IDS and is the only current way to remove air introduced upstream of the HCU. If you have removed the master cylinder or have allowed the master cylinder to empty of brake fluid, you are likely to be in this category.

Jack up the car and place securely onto Axle Stands.

Make sure the engine is off & you have pumped the brake pedal so that no pressure remains in the servo. There is a bleed nipple on each brake calliper, you should attach a piece of pipe to the Near Side Rear (passenger side) calliper.

Make sure the end of the pipe is in a jar with some clean new brake fluid (you should use new Fluid only. LR Spec is SHELL DONAX YB DOT4 ESL FLUID. Otherwise, use a low viscosity DOT 4 brake fluid meeting ISO 4925 Class 6 and Land Rover LRES22BF03 requirements.

Fill the brake reservoir to Max,

Undo the brake bleed nipple by 1/2 to 3/4 of a turn.

Get an assistant to gently press the brake pedal all the way down and then let it return to the top. Repeat until a flow of clean air free fluid is going into the bleed jar.

On the last downward pump of the brake pedal, hold it down and tighten the bleed nipple to 10Nm.

Fill the brake reservoir to Max again and repeat the procedure for each wheel in the following order. Starting at Left side Rear, then Right side Rear then Left side Front and Right Side Front. Regularly checking that the level in the master cylinder hasn't gone below minimum level.

2) Complete change of fluid, do in the same way as 1, although there would still be some fluid in the ABS control unit, but it would all get mixed in as it's used once you've bled them all.

© Copyright Ian Bodsworth 2011. All descriptions and photo's contained within remain the property of the Author. Commercial images of products with copyrights acknowledged. E&OE. - Created by Bodsby – Disco3Club

You should generally notice that the old fluid is a darker colour than the new fluid, so you should keep pumping fluid through until the clean stuff comes out. make sure you have plenty of spare fluid of the right spec.

When bleeding the fluid, you should attach a tube to the bleed nipple & ensure that the end of the tube is in a jar with some new fluid in just to avoid air or old fluid being sucked back in.

3) Using the BBS Faultmate or IDS/T4 system to bleed the brake unit (not likely to happen for most DIY servicers!)

Hope that helps!

Where to buy from.....

- LandRover directly, I've found Yeovil Landrover to be very accommodating for Genuine LR Parts. Mention Bodsy's Brake Bible and you may get extra discount.
- Speak to Nick the Parts Manager - 01935 476660
- For Non OEM parts, then I've found 4-Tech Land Rover specialists to also be very accommodating. Likewise, mention Bodsy's Brake Bible and you may get extra discount.
- Speak to Gordon 01945 871335
- For Tools, all of the tools used in this guide are widely available from your local tool supplier. Such as Halfords or your local autoparts store.

Other details requested by users of this guide.....

Donations

If you feel you have made good use of this guide to avoid dealers extortionate rates and would like to make a contribution to help write more guides & to keep this one updated, please feel free to Paypal me through this link [HERE](#)

https://www.paypal.com/cgi-bin/webscr?cmd=_s-xclick&hosted_button_id=C7VFKWHQJ66W8

or paypal directly to D3Bodsy@yahoo.co.uk

No pressure to do so, this guide is free for you to use, but as they say, every little helps ;-)

Other services

I now have the capability to provide software updates to your Discovery 3 in the UK (other countries may be possible).

Fault Code Reading and resetting

Service Light Reset

Activate 4x4 Information display screen & off road Sat Nav.

Telephone module updates to avoid problems with newer mobile phones and to enable use of your phone phonebook through the LR system (only available with factory fit telephone modules).

Switch on Three Flash Indicators

Enable Lights on Indicator with extra Clock in your dashboard (pre MY07)

Enable you to change your satnav destination whilst on the move (for pre MY07 vehicles)

Please e-mail me for more information. I can arrange for updates to be done in most areas of the UK (although some areas are more difficult than others)

If you have a Multi Vehicle Faultmate and can already do these updates, please contact me.

Bodsys' Brake Bible

a

DISCO3CLUB

Resource